

## FEATURES

- **500ksps Throughput Rate**
- **16-Bit Resolution with No Missing Codes**
- **8-Channel Multiplexer with Selectable Input Range**
  - **Fully Differential ( $\pm 4.096V$ )**
  - **Pseudo-Differential Unipolar ( $0V$  to  $4.096V$ )**
  - **Pseudo-Differential Bipolar ( $\pm 2.048V$ )**
- **INL:  $\pm 1LSB$  (Maximum)**
- **SNR: 96dB (Fully Differential)/93.5dB (Pseudo-Differential) (Typical) at  $f_{IN} = 1kHz$**
- **THD:  $-110dB$  (Typical) at  $f_{IN} = 1kHz$**
- Programmable Sequencer
- Selectable Digital Gain Compression
- Single 5V Supply with 1.8V to 5V I/O Voltages
- SPI-Compatible Serial I/O
- Onboard 2.048V Reference and Reference Buffer
- No Pipeline Delay, No Cycle Latency
- Power Dissipation 27mW (Typical)
- Guaranteed Operation to 125°C
- 32-Lead 5mm  $\times$  5mm QFN Package

## APPLICATIONS

- Programmable Logic Controllers
- Industrial Process Control
- High Speed Data Acquisition
- Portable or Compact Instrumentation
- ATE

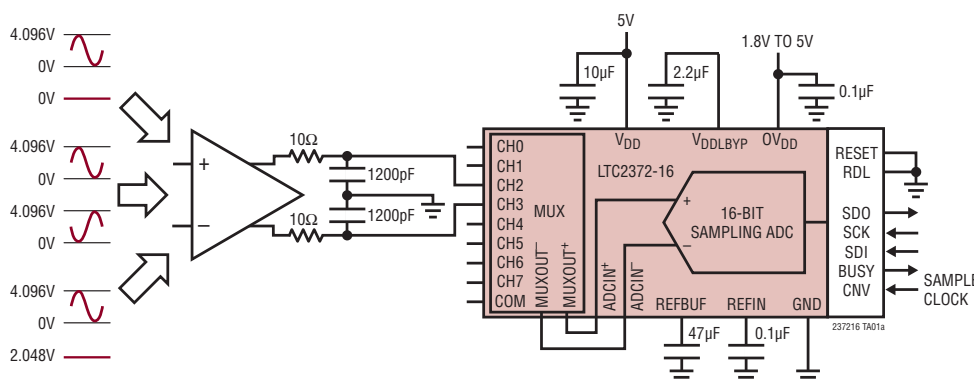
## DESCRIPTION

The **LTC<sup>®</sup>2372-16** is a low noise, high speed, 8-channel 16-bit successive approximation register (SAR) ADC. Operating from a single 5V supply, the LTC2372-16 has a highly configurable, low crosstalk 8-channel input multiplexer, supporting fully differential, pseudo-differential unipolar and pseudo-differential bipolar analog input ranges. The LTC2372-16 achieves  $\pm 1LSB$  INL (maximum) in all input ranges, no missing codes at 16-bits and 96dB (fully differential)/93.5dB (pseudo-differential) SNR (typical).

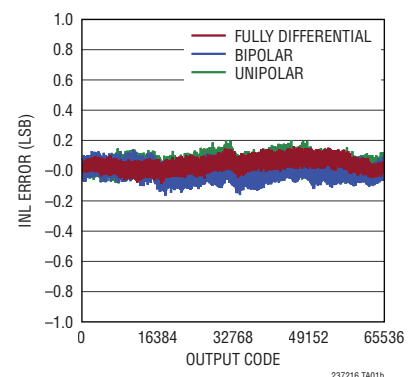
The LTC2372-16 has an onboard low drift (20ppm/°C max) 2.048V temperature-compensated reference and a single-shot capable reference buffer. The LTC2372-16 also has a high speed SPI-compatible serial interface that supports 1.8V, 2.5V, 3.3V and 5V logic through which a sequencer with a depth of 16 may be programmed. An internal oscillator sets the conversion time, easing external timing considerations. The LTC2372-16 dissipates only 27mW and automatically naps between conversions, leading to reduced power dissipation that scales with the sampling rate. A sleep mode is also provided to reduce the power consumption of the LTC2372-16 to 300 $\mu$ W for further power savings during inactive periods.

LT, LT, LTC, LTM, Linear Technology and the Linear logo are registered trademarks and SoftSpan is a trademark of Linear Technology Corporation. All other trademarks are the property of their respective owners. Protected by U.S. Patents, including 7705765, 7961132, 8319673.

## TYPICAL APPLICATION



**Integral Nonlinearity vs Output Code**



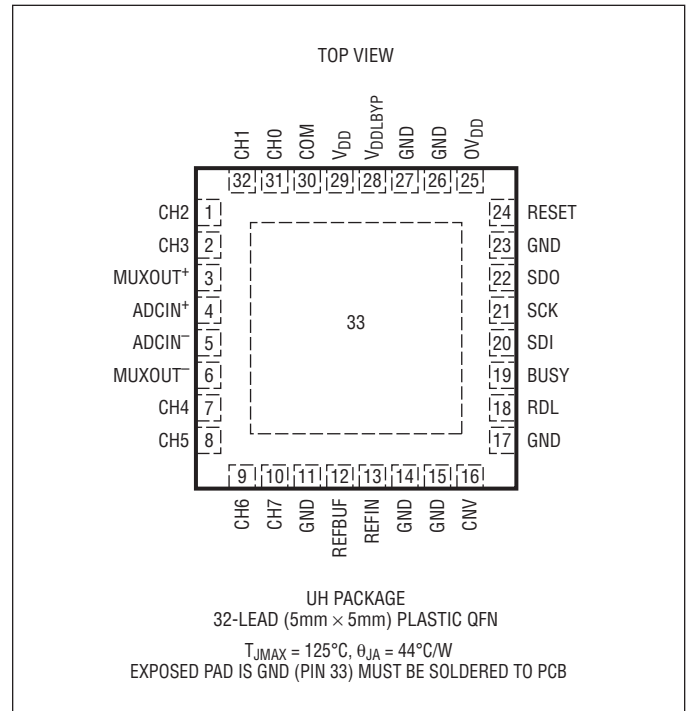
# LTC2372-16

## ABSOLUTE MAXIMUM RATINGS

(Notes 1, 2)

Supply Voltage ( $V_{DD}$ )	6V
Supply Voltage ( $OV_{DD}$ )	6V
Analog Input Voltage (Note 3)	
CH0 to CH7, COM	(GND - 0.3V) to ( $V_{DD} + 0.3V$ )
REFBUF	(GND - 0.3V) to ( $V_{DD} + 0.3V$ )
REFIN	2.8V
Digital Input Voltage	
(Note 3)	(GND - 0.3V) to ( $OV_{DD} + 0.3V$ )
Digital Output Voltage	
(Note 3)	(GND - 0.3V) to ( $OV_{DD} + 0.3V$ )
Power Dissipation	500mW
Operating Temperature Range	
LTC2372C	0°C to 70°C
LTC2372I	-40°C to 85°C
LTC2372H	-40°C to 125°C
Storage Temperature Range	-65°C to 150°C

## PIN CONFIGURATION



## ORDER INFORMATION

LEAD FREE FINISH	TAPE AND REEL	PART MARKING*	PACKAGE DESCRIPTION	TEMPERATURE RANGE
LTC2372CUH-16#PBF	LTC2372CUH-16#TRPBF	237216	32-Lead (5mm × 5mm) Plastic QFN	0°C to 70°C
LTC2372IUH-16#PBF	LTC2372IUH-16#TRPBF	237216	32-Lead (5mm × 5mm) Plastic QFN	-40°C to 85°C
LTC2372HUH-16#PBF	LTC2372HUH-16#TRPBF	237216	32-Lead (5mm × 5mm) Plastic QFN	-40°C to 125°C

Consult LTC Marketing for parts specified with wider operating temperature ranges. \*The temperature grade is identified by a label on the shipping container. Consult LTC Marketing for information on nonstandard lead based finish parts.

For more information on lead free part marking, go to: <http://www.linear.com/leadfree/>

For more information on tape and reel specifications, go to: <http://www.linear.com/tapeandreeel/>

## ELECTRICAL CHARACTERISTICS

The ● denotes the specifications which apply over the full operating temperature range, otherwise specifications are at  $T_A = 25^\circ\text{C}$ . (Note 4)

SYMBOL	PARAMETER	CONDITIONS	MIN	TYP	MAX	UNITS	
$V_{IN}^+$	Absolute Input Range (CH0 to CH7)	(Note 5)	●	-0.1	$V_{REFBUF} + 0.1$	V	
$V_{IN}^-$	Absolute Input Range (CH0 to CH7, COM)	Fully Differential (Note 5)	●	-0.1	$V_{REFBUF} + 0.1$	V	
		Pseudo-Differential Unipolar (Note 5)	●	-0.1	0	0.1	V
		Pseudo-Differential Bipolar (Note 5)	●	$V_{REFBUF}/2 - 0.1$	$V_{REFBUF}/2$	$V_{REFBUF}/2 + 0.1$	V
$V_{IN}^+ - V_{IN}^-$	Input Differential Voltage Range	Fully Differential	●	$-V_{REFBUF}$	$V_{REFBUF}$	V	
		Pseudo-Differential Unipolar	●	0	$V_{REFBUF}$	V	
		Pseudo-Differential Bipolar	●	$-V_{REFBUF}/2$	$V_{REFBUF}/2$	V	
$V_{CM}$	Common Mode Input Range	Pseudo-Differential Bipolar and Fully Differential (Note 6)	●	$-V_{REFBUF}/2 - 0.1$	$V_{REFBUF}/2 + 0.1$	V	
$I_{IN}$	Analog Input Leakage Current		●	-1	1	$\mu\text{A}$	
$C_{IN}$	Analog Input Capacitance	Sample Mode		75		pF	
		Hold Mode		5		pF	
CMRR	Input Common Mode Rejection Ratio	Fully Differential, $f_{IN} = 250\text{kHz}$		71		dB	
		Pseudo-Differential Unipolar, $f_{IN} = 250\text{kHz}$		72		dB	
		Pseudo-Differential Bipolar, $f_{IN} = 250\text{kHz}$		73		dB	

## CONVERTER CHARACTERISTICS

The ● denotes the specifications which apply over the full operating temperature range, otherwise specifications are at  $T_A = 25^\circ\text{C}$ . (Note 4)

SYMBOL	PARAMETER	CONDITIONS	MIN	TYP	MAX	UNITS	
	Resolution		●	16		Bits	
	No Missing Codes		●	16		Bits	
	Transition Noise	Fully Differential		0.25		$\text{LSB}_{RMS}$	
		Pseudo-Differential Unipolar		0.5		$\text{LSB}_{RMS}$	
		Pseudo-Differential Bipolar		0.5		$\text{LSB}_{RMS}$	
INL	Integral Linearity Error	Fully Differential (Note 7)	●	-1	$\pm 0.1$	1	LSB
		Pseudo-Differential Unipolar (Note 7)	●	-1	$\pm 0.1$	1	LSB
		Pseudo-Differential Bipolar (Note 7)	●	-1	$\pm 0.1$	1	LSB
DNL	Differential Linearity Error	Fully Differential (Note 6)	●	-0.5	$\pm 0.1$	0.5	LSB
		Pseudo-Differential Unipolar (Note 6)	●	-0.5	$\pm 0.1$	0.5	LSB
		Pseudo-Differential Bipolar (Note 6)	●	-0.5	$\pm 0.1$	0.5	LSB
ZSE	Zero-Scale Error	Fully Differential (Note 8)	●	-6	$\pm 0.5$	6	LSB
		Pseudo-Differential Unipolar (Note 8)	●	-6	$\pm 0.5$	6	LSB
		Pseudo-Differential Bipolar (Note 8)	●	-8	$\pm 0.5$	8	LSB
	Zero-Scale Error Drift	Fully Differential		1		$\text{mLSB}/^\circ\text{C}$	
		Pseudo-Differential Unipolar		2		$\text{mLSB}/^\circ\text{C}$	
		Pseudo-Differential Bipolar		2		$\text{mLSB}/^\circ\text{C}$	
	Zero-Scale Error Match	Fully Differential	●	-6	$\pm 0.5$	6	LSB
		Pseudo-Differential Unipolar	●	-7	$\pm 1$	7	LSB
		Pseudo-Differential Bipolar	●	-8	$\pm 1$	8	LSB
FSE	Full-Scale Error	Fully Differential	●	-15	$\pm 2$	15	LSB
		REFBUF = 4.096V (REFBUF Overdriven) (Notes 8, 9)	●	-25	$\pm 3$	25	LSB
		REFIN = 2.048V (REFIN Overdriven) (Note 8)					
		Pseudo-Differential Unipolar	●	-20	$\pm 1$	20	LSB
		REFBUF = 4.096V (REFBUF Overdriven) (Notes 8, 9)	●	-50	$\pm 4$	50	LSB
		REFIN = 2.048V (REFIN Overdriven) (Note 8)					
	Zero-Scale Error Match	Pseudo-Differential Bipolar	●	-15	$\pm 2$	-15	LSB
		REFBUF = 4.096V (REFBUF Overdriven) (Notes 8, 9)	●	-30	$\pm 3$	30	LSB
		REFIN = 2.048V (REFIN Overdriven) (Note 8)					

237216f

**CONVERTER CHARACTERISTICS** The ● denotes the specifications which apply over the full operating temperature range, otherwise specifications are at T<sub>A</sub> = 25°C. (Note 4)

SYMBOL	PARAMETER	CONDITIONS	MIN	TYP	MAX	UNITS	
	Full-Scale Error Drift	Fully Differential REFBUF = 4.096V (REFBUF Overdriven) (Note 9)		0.2		ppm/°C	
		Pseudo-Differential Unipolar REFBUF = 4.096V (REFBUF Overdriven) (Note 9)		0.2		ppm/°C	
		Pseudo-Differential Bipolar REFBUF = 4.096V (REFBUF Overdriven) (Note 9)		0.2		ppm/°C	
	Full-Scale Error Match	Fully Differential REFBUF = 4.096V (REFBUF Overdriven) (Note 9)	●	-6	±0.5	6	LSB
		Pseudo-Differential Unipolar REFBUF = 4.096V (REFBUF Overdriven) (Note 9)	●	-7	±1	7	LSB
		Pseudo-Differential Bipolar REFBUF = 4.096V (REFBUF Overdriven) (Note 9)	●	-8	±1	8	LSB

**DYNAMIC ACCURACY** The ● denotes the specifications which apply over the full operating temperature range, otherwise specifications are at T<sub>A</sub> = 25°C and A<sub>IN</sub> = -1dBFS. (Notes 4, 10)

SYMBOL	PARAMETER	CONDITIONS	MIN	TYP	MAX	UNITS	
SINAD	Signal-to-(Noise + Distortion) Ratio	Fully Differential f <sub>IN</sub> = 1kHz, REFIN = 2.048V (REFIN Overdriven)	●	93	96		dB
		Pseudo-Differential Unipolar f <sub>IN</sub> = 1kHz, REFIN = 2.048V (REFIN Overdriven)	●	90	93.4		dB
		Pseudo-Differential Bipolar f <sub>IN</sub> = 1kHz, REFIN = 2.048V (REFIN Overdriven)	●	90	93.4		dB
		Fully Differential f <sub>IN</sub> = 1kHz, REFBUF = 5V (REFBUF Overdriven) (Note 9)			97		dB
		Pseudo-Differential Unipolar f <sub>IN</sub> = 1kHz, REFBUF = 5V (REFBUF Overdriven) (Note 9)			94.5		dB
		Pseudo-Differential Bipolar f <sub>IN</sub> = 1kHz, REFBUF = 5V (REFBUF Overdriven) (Note 9)			94.5		dB
		Fully Differential f <sub>IN</sub> = 1kHz, REFIN = 2.048V (REFIN Overdriven), SEL = 1			95		dB
		Pseudo-Differential Bipolar f <sub>IN</sub> = 1kHz, REFIN = 2.048V (REFIN Overdriven), SEL = 1			91.5		dB
SNR	Signal-to-Noise Ratio	Fully Differential f <sub>IN</sub> = 1kHz, REFIN = 2.048V (REFIN Overdriven)	●	93	96		dB
		Pseudo-Differential Unipolar f <sub>IN</sub> = 1kHz, REFIN = 2.048V (REFIN Overdriven)	●	90	93.4		dB
		Pseudo-Differential Bipolar f <sub>IN</sub> = 1kHz, REFIN = 2.048V (REFIN Overdriven)	●	90	93.4		dB
		Fully Differential f <sub>IN</sub> = 1kHz, REFBUF = 5V (REFBUF Overdriven) (Note 9)			97		dB
		Pseudo-Differential Unipolar f <sub>IN</sub> = 1kHz, REFBUF = 5V (REFBUF Overdriven) (Note 9)			94.5		dB
		Pseudo-Differential Bipolar f <sub>IN</sub> = 1kHz, REFBUF = 5V (REFBUF Overdriven) (Note 9)			94.5		dB
		Fully Differential f <sub>IN</sub> = 1kHz, REFIN = 2.048V (REFIN Overdriven), SEL = 1			95		dB
		Pseudo-Differential Bipolar f <sub>IN</sub> = 1kHz, REFIN = 2.048V (REFIN Overdriven), SEL = 1			91.5		dB

**DYNAMIC ACCURACY** The ● denotes the specifications which apply over the full operating temperature range, otherwise specifications are at  $T_A = 25^\circ\text{C}$  and  $A_{IN} = -1\text{dBFS}$ . (Notes 4, 10)

SYMBOL	PARAMETER	CONDITIONS	MIN	TYP	MAX	UNITS		
THD	Total Harmonic Distortion	Fully Differential $f_{IN} = 1\text{kHz}$ , $REFIN = 2.048\text{V}$ (REFIN Overdriven)	●	-114	-101	dB		
		Pseudo-Differential Unipolar $f_{IN} = 1\text{kHz}$ , $REFIN = 2.048\text{V}$ (REFIN Overdriven)	●	-110	-100	dB		
		Pseudo-Differential Bipolar $f_{IN} = 1\text{kHz}$ , $REFIN = 2.048\text{V}$ (REFIN Overdriven)	●	-110	-100	dB		
		Fully Differential $f_{IN} = 1\text{kHz}$ , $REFBUF = 5\text{V}$ (REFBUF Overdriven) (Note 9)		-111		dB		
		Pseudo-Differential Unipolar $f_{IN} = 1\text{kHz}$ , $REFBUF = 5\text{V}$ (REFBUF Overdriven) (Note 9)		-110		dB		
		Pseudo-Differential Bipolar $f_{IN} = 1\text{kHz}$ , $REFBUF = 5\text{V}$ (REFBUF Overdriven) (Note 9)		-110		dB		
		Fully Differential $f_{IN} = 1\text{kHz}$ , $REFIN = 2.048\text{V}$ (REFIN Overdriven), $SEL = 1$		-113		dB		
		Pseudo-Differential Bipolar $f_{IN} = 1\text{kHz}$ , $REFIN = 2.048\text{V}$ (REFIN Overdriven), $SEL = 1$		-110		dB		
		SFDR	Spurious Free Dynamic Range	Fully Differential $f_{IN} = 1\text{kHz}$ , $REFIN = 2.048\text{V}$ (REFIN Overdriven)	●	101	114	dB
				Pseudo-Differential Unipolar $f_{IN} = 1\text{kHz}$ , $REFIN = 2.048\text{V}$ (REFIN Overdriven)	●	100	110	dB
Pseudo-Differential Bipolar $f_{IN} = 1\text{kHz}$ , $REFIN = 2.048\text{V}$ (REFIN Overdriven)	●			100	110	dB		
Fully Differential $f_{IN} = 1\text{kHz}$ , $REFBUF = 5\text{V}$ (REFBUF Overdriven) (Note 9)					112	dB		
Pseudo-Differential Unipolar $f_{IN} = 1\text{kHz}$ , $REFBUF = 5\text{V}$ (REFBUF Overdriven) (Note 9)					112	dB		
Pseudo-Differential Bipolar $f_{IN} = 1\text{kHz}$ , $REFBUF = 5\text{V}$ (REFBUF Overdriven) (Note 9)					112	dB		
Fully Differential $f_{IN} = 1\text{kHz}$ , $REFIN = 2.048\text{V}$ (REFIN Overdriven), $SEL = 1$					112.5	dB		
Pseudo-Differential Bipolar $f_{IN} = 1\text{kHz}$ , $REFIN = 2.048\text{V}$ (REFIN Overdriven), $SEL = 1$					113.5	dB		
Channel-to-Channel Crosstalk	$f_{IN} = 100\text{kHz}$ , Signal Applied to an OFF Channel					-107	dB	
-3dB Input Linear Bandwidth						22	MHz	
Aperture Delay				500	ps			
Aperture Jitter				4	ps <sub>RMS</sub>			
Transient Response	Full-Scale Step			0.5	μs			

**INTERNAL REFERENCE CHARACTERISTICS** The ● denotes the specifications which apply over the full operating temperature range, otherwise specifications are at  $T_A = 25^\circ\text{C}$ . (Note 4)

SYMBOL	PARAMETER	CONDITIONS	MIN	TYP	MAX	UNITS
$V_{REFIN}$	Internal Reference Output Voltage		2.043	2.048	2.053	V
	$V_{REFIN}$ Temperature Coefficient	(Note 11)		● 4	20	ppm/ $^\circ\text{C}$
	REFIN Output Impedance			15		kΩ
	$V_{REFIN}$ Line Regulation	$V_{DD} = 4.75\text{V}$ to $5.25\text{V}$		0.06		mV/V
	REFIN Input Voltage Range	(REFIN Overdriven) (Note 5)	1.25		2.4	V

## REFERENCE BUFFER CHARACTERISTICS

The ● denotes the specifications which apply over the full operating temperature range, otherwise specifications are at  $T_A = 25^\circ\text{C}$ . (Note 4)

SYMBOL	PARAMETER	CONDITIONS	MIN	TYP	MAX	UNITS
$V_{\text{REFBUF}}$	Reference Buffer Output Voltage	$V_{\text{REFIN}} = 2.048\text{V}$	● 4.088	4.096	4.104	V
	REFBUF Input Voltage Range	(REFBUF Overdriven) (Notes 5, 9)	● 2.5		5	V
	REFBUF Output Impedance	$V_{\text{REFIN}} = 0\text{V}$ (Buffer Disabled)		13		k $\Omega$
$I_{\text{REFBUF}}$	REFBUF Load Current	$V_{\text{REFBUF}} = 5\text{V}$ (REFBUF Overdriven) (Notes 9, 12) $V_{\text{REFBUF}} = 5\text{V}$ , Nap Mode (REFBUF Overdriven) (Note 9)	●	0.7 0.38	1	mA mA

## DIGITAL INPUTS AND DIGITAL OUTPUTS

The ● denotes the specifications which apply over the full operating temperature range, otherwise specifications are at  $T_A = 25^\circ\text{C}$ . (Note 4)

SYMBOL	PARAMETER	CONDITIONS	MIN	TYP	MAX	UNITS
$V_{\text{IH}}$	High Level Input Voltage		● $0.8 \cdot OV_{\text{DD}}$			V
$V_{\text{IL}}$	Low Level Input Voltage		●		$0.2 \cdot OV_{\text{DD}}$	V
$I_{\text{IN}}$	Digital Input Current	$V_{\text{IN}} = 0\text{V}$ to $OV_{\text{DD}}$	● -10		10	$\mu\text{A}$
$C_{\text{IN}}$	Digital Input Capacitance			5		pF
$V_{\text{OH}}$	High Level Output Voltage	$I_{\text{O}} = -500\mu\text{A}$	● $OV_{\text{DD}} - 0.2$			V
$V_{\text{OL}}$	Low Level Output Voltage	$I_{\text{O}} = 500\mu\text{A}$	●		0.2	V
$I_{\text{OZ}}$	Hi-Z Output Leakage Current	$V_{\text{OUT}} = 0\text{V}$ to $OV_{\text{DD}}$	● -10		10	$\mu\text{A}$
$I_{\text{SOURCE}}$	Output Source Current	$V_{\text{OUT}} = 0\text{V}$		-10		mA
$I_{\text{SINK}}$	Output Sink Current	$V_{\text{OUT}} = OV_{\text{DD}}$		10		mA

## POWER REQUIREMENTS

The ● denotes the specifications which apply over the full operating temperature range, otherwise specifications are at  $T_A = 25^\circ\text{C}$ . (Note 4)

SYMBOL	PARAMETER	CONDITIONS	MIN	TYP	MAX	UNITS
$V_{\text{DD}}$	Supply Voltage		● 4.75	5	5.25	V
$OV_{\text{DD}}$	Supply Voltage		● 1.71		5.25	V
$I_{\text{VDD}}$	Supply Current	500ksps Sample Rate	●	5.4	7	mA
$I_{\text{OVDD}}$	Supply Current	500ksps Sample Rate ( $C_L = 20\text{pF}$ )	●	0.35		mA
$I_{\text{NAP}}$	Nap Mode Current	Conversion Done ( $I_{\text{VDD}} + I_{\text{OVDD}}$ )	●	1.25	1.5	mA
$I_{\text{SLEEP}}$	Sleep Mode Current	Sleep Mode ( $I_{\text{VDD}} + I_{\text{OVDD}}$ )	●	60	120	$\mu\text{A}$
$P_{\text{D}}$	Power Dissipation	500ksps Sample Rate		27	35	mW
	Nap Mode	Conversion Done ( $I_{\text{VDD}} + I_{\text{OVDD}}$ )		6.25	7.5	mW
	Sleep Mode	Sleep Mode ( $I_{\text{VDD}} + I_{\text{OVDD}}$ )		300	600	$\mu\text{W}$

## ADC TIMING CHARACTERISTICS

The ● denotes the specifications which apply over the full operating temperature range, otherwise specifications are at  $T_A = 25^\circ\text{C}$ . (Note 4)

SYMBOL	PARAMETER	CONDITIONS	MIN	TYP	MAX	UNITS
$f_{\text{SMPL}}$	Maximum Sampling Frequency		●		500	ksps
$t_{\text{CONV}}$	Conversion Time		● 1		1.5	$\mu\text{s}$
$t_{\text{ACQ}}$	Acquisition Time	$t_{\text{ACQ}} = t_{\text{CYC}} - t_{\text{HOLD}}$ (Note 6)	● 1.46			$\mu\text{s}$
$t_{\text{HOLD}}$	Maximum Time Between Acquisitions		●		540	ns
$t_{\text{CYC}}$	Time Between Conversions		● 2			$\mu\text{s}$
$t_{\text{CNVH}}$	CNV High Time		● 20			ns
$t_{\text{CNVL}}$	Minimum Low Time for CNV	(Note 13)	● 20			ns
$t_{\text{BUSYLH}}$	CNV $\uparrow$ to BUSY $\uparrow$ Delay	$C_L = 20\text{pF}$	●		13	ns
$t_{\text{RESETH}}$	RESET Pulse Width		● 200			ns

## ELECTRICAL CHARACTERISTICS

The ● denotes the specifications which apply over the full operating temperature range, otherwise specifications are at  $T_A = 25^\circ\text{C}$ . (Note 4)

$t_{\text{QUIET}}$	SCK, SDI and RDL Quiet Time from CNV $\uparrow$	(Note 6)	●	20	ns
$t_{\text{SCK}}$	SCK Period	(Notes 13, 14)	●	10	ns
$t_{\text{SCKH}}$	SCK High Time		●	4	ns
$t_{\text{SCKL}}$	SCK Low Time		●	4	ns
$t_{\text{SSDISCK}}$	SDI Setup Time From SCK $\uparrow$	(Note 13)	●	4	ns
$t_{\text{HSDISCK}}$	SDI Hold Time From SCK $\uparrow$	(Note 13)	●	1	ns
$t_{\text{DSDO}}$	SDO Data Valid Delay from SCK $\uparrow$	$C_L = 20\text{pF}$ , $OV_{DD} = 5.25\text{V}$ $C_L = 20\text{pF}$ , $OV_{DD} = 2.5\text{V}$ $C_L = 20\text{pF}$ , $OV_{DD} = 1.71\text{V}$	● ● ●	7.5 8 9.5	ns ns ns
$t_{\text{HSDO}}$	SDO Data Remains Valid Delay from SCK $\uparrow$	$C_L = 20\text{pF}$ (Note 6)	●	1	ns
$t_{\text{DSDOBUSYL}}$	SDO Data Valid Delay from BUSY $\downarrow$	$C_L = 20\text{pF}$ (Note 6)	●	5	ns
$t_{\text{EN}}$	Bus Enable Time After RDL $\downarrow$	(Note 13)	●	16	ns
$t_{\text{DIS}}$	Bus Relinquish Time After RDL $\uparrow$	(Note 13)	●	13	ns
$t_{\text{WAKE}}$	REFBUF Wake-Up Time	$C_{\text{REFBUF}} = 47\mu\text{F}$ , $C_{\text{REFIN}} = 0.1\mu\text{F}$		200	ms
$t_{\text{CNVMRST}}$	CNV $\uparrow$ to MUX Starts Resetting Delay		●	38	ns
$t_{\text{MRST1}}$	MUX Reset Time During Conversion		●	36	ns
$t_{\text{VLDMRST}}$	8th SCK $\uparrow$ to MUX Starts Resetting Delay After Programming 1st Valid Configuration Word		●	40	ns
$t_{\text{MRST2}}$	MUX Reset Time During Acquisition After Programming 1st Valid Configuration Word		●	42	ns

**Note 1:** Stresses beyond those listed under Absolute Maximum Ratings may cause permanent damage to the device. Exposure to any Absolute Maximum Rating condition for extended periods may affect device reliability and lifetime.

**Note 2:** All voltage values are with respect to ground.

**Note 3:** When these pin voltages are taken below ground or above  $V_{DD}$  or  $OV_{DD}$ , they will be clamped by internal diodes. This product can handle input currents up to 100mA below ground or above  $V_{DD}$  or  $OV_{DD}$  without latchup.

**Note 4:**  $V_{DD} = 5\text{V}$ ,  $OV_{DD} = 2.5\text{V}$ ,  $f_{\text{SMPL}} = 500\text{kHz}$ ,  $\text{REFIN} = 2.048\text{V}$  unless otherwise noted.

**Note 5:** Recommended operating conditions.

**Note 6:** Guaranteed by design, not subject to test.

**Note 7:** Integral nonlinearity is defined as the deviation of a code from a straight line passing through the actual endpoints of the transfer curve. The deviation is measured from the center of the quantization band.

**Note 8:** Fully differential zero-scale error is the offset voltage measured from  $-0.5\text{LSB}$  when the output code flickers between 0111 1111 1111 1111 and 1000 0000 0000 0000 in straight binary format and 0000 0000 0000 0000 and 1111 1111 1111 1111 in two's complement format. Unipolar zero-scale error is the offset voltage measured from  $0.5\text{LSB}$  when the

output code flickers between 0000 0000 0000 0000 and 0000 0000 0000 0001. Bipolar zero-scale error is the offset voltage measured from  $-0.5\text{LSB}$  when the output code flickers between 0000 0000 0000 0000 and 1111 1111 1111 1111. Fully differential full-scale error is the worst-case deviation of the first and last code transitions from ideal and includes the effect of offset error. Unipolar full-scale error is the deviation of the last code transition from the ideal and includes the effect of offset error. Bipolar full-scale error is the worst-case deviation of the first and last code transitions from ideal and includes the effect of offset error.

**Note 9:** When REFBUF is overdriven, the internal reference buffer must be turned off by setting  $\text{REFIN} = 0\text{V}$ .

**Note 10:** All specifications in dB are referred to a full-scale  $\pm V_{\text{REFBUF}}$  (fully differential),  $0\text{V}$  to  $V_{\text{REFBUF}}$  (pseudo-differential unipolar), or  $\pm V_{\text{REFBUF}}/2$  (pseudo-differential bipolar) input.

**Note 11:** Temperature coefficient is calculated by dividing the maximum change in output voltage by the specified temperature range.

**Note 12:**  $f_{\text{SMPL}} = 500\text{kHz}$ ,  $I_{\text{REFBUF}}$  varies proportionally with sample rate.

**Note 13:** Parameter tested and guaranteed at  $OV_{DD} = 1.71\text{V}$ ,  $OV_{DD} = 2.5\text{V}$  and  $OV_{DD} = 5.25\text{V}$ .

**Note 14:**  $t_{\text{SCK}}$  of 10ns maximum allows a shift clock frequency up to 100MHz for rising edge capture.

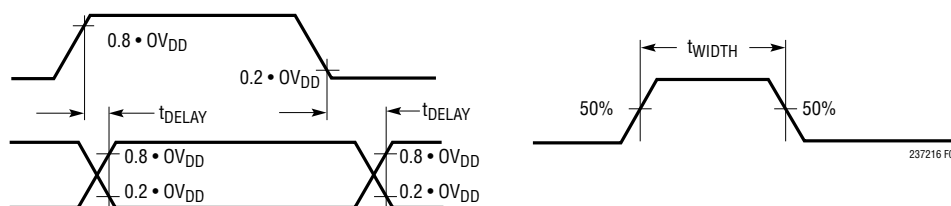
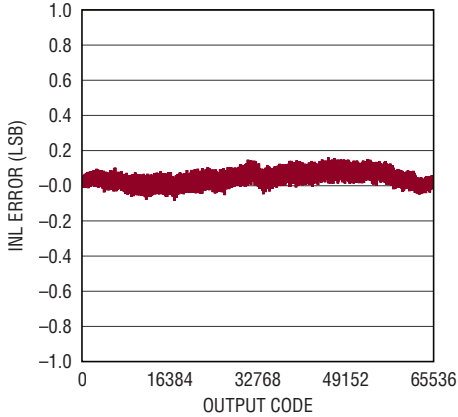


Figure 1. Voltage Levels for Timing Specifications

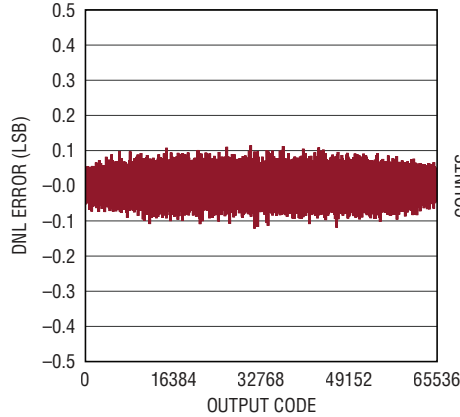
## TYPICAL PERFORMANCE CHARACTERISTICS $T_A = 25^\circ\text{C}$ , $V_{DD} = 5\text{V}$ , $0V_{DD} = 2.5\text{V}$ , $\text{REF}_{IN} = 2.048\text{V}$ , Fully Differential Range, $V_{CM} = 2.048\text{V}$ , $f_{SAMPL} = 500\text{kps}$ , unless otherwise noted.

**Integral Nonlinearity vs Output Code**



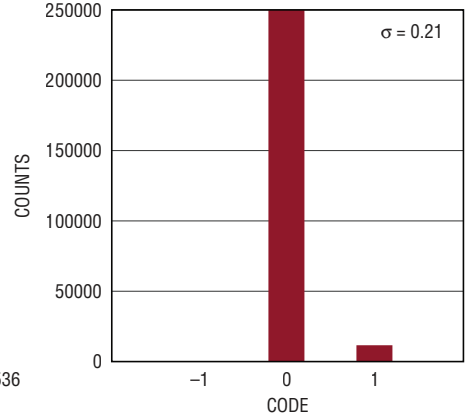
237216 G01

**Differential Nonlinearity vs Output Code**



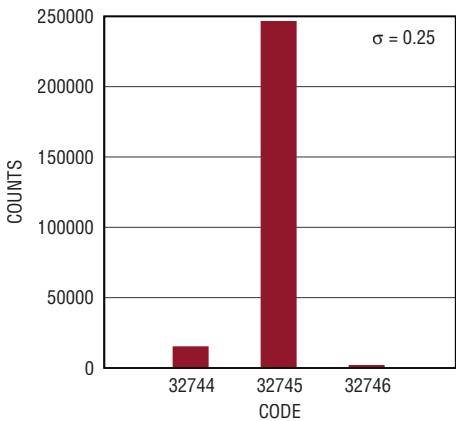
237216 G02

**DC Histogram (Near Zero-Scale)**



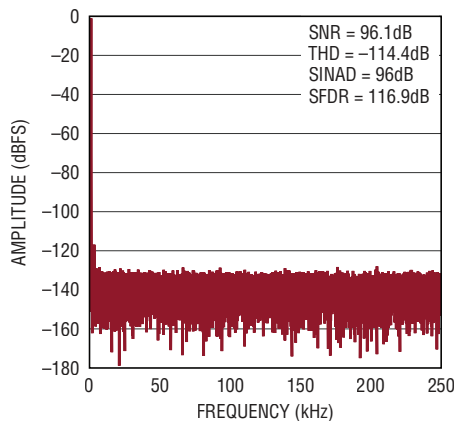
237216 G03

**DC Histogram (Near Full-Scale)**



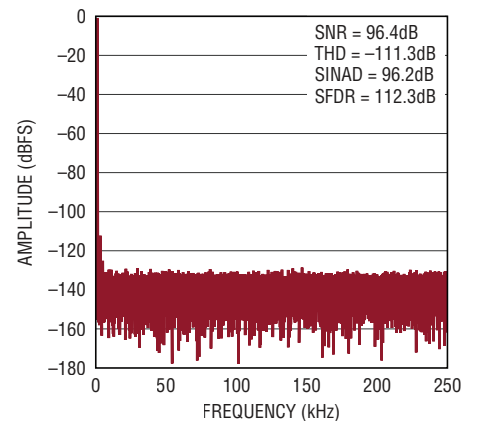
237216 G04

**32k Point FFT  $f_{SAMPL} = 500\text{kps}$ ,  $f_{IN} = 1\text{kHz}$**



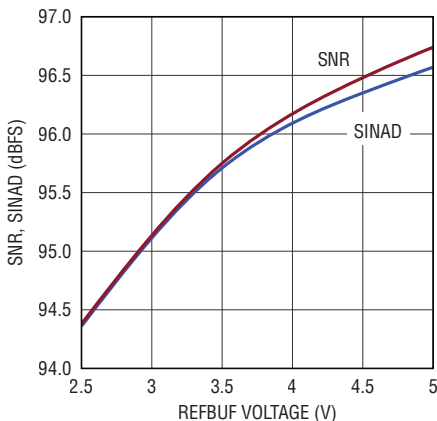
237216 G05

**32k Point FFT  $f_{SAMPL} = 500\text{kps}$ ,  $f_{IN} = 1\text{kHz}$ ,  $\text{REF}_{BUF} = 5\text{V}$**



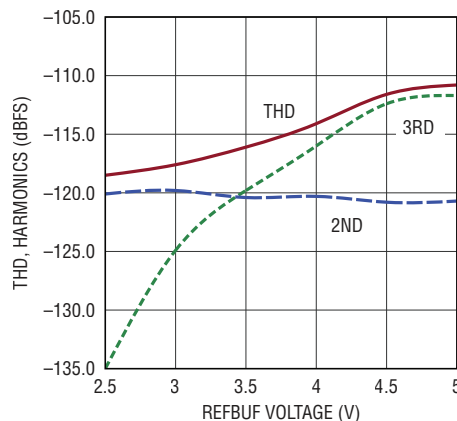
237216 G06

**SNR, SINAD vs  $\text{REF}_{BUF}$ ,  $f_{IN} = 1\text{kHz}$**



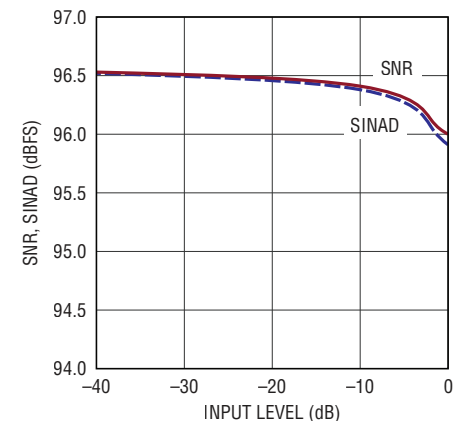
237216 G07

**THD, Harmonics vs  $\text{REF}_{BUF}$ ,  $f_{IN} = 1\text{kHz}$**



237216 G08

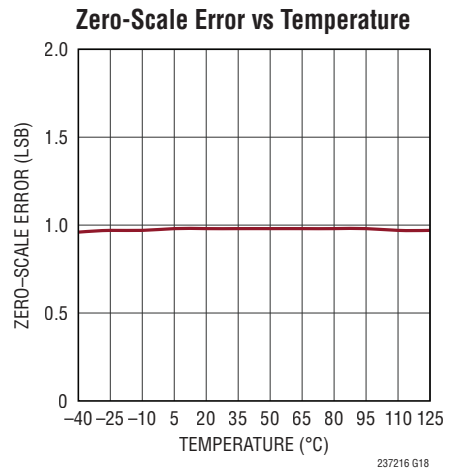
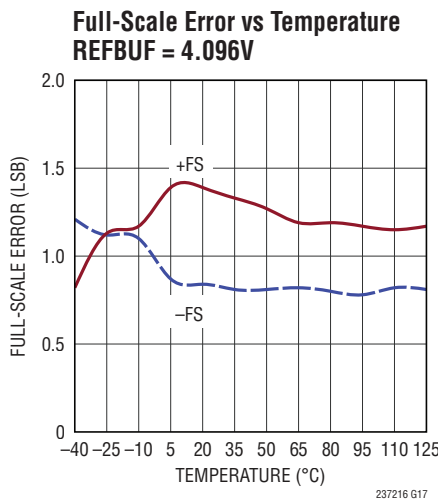
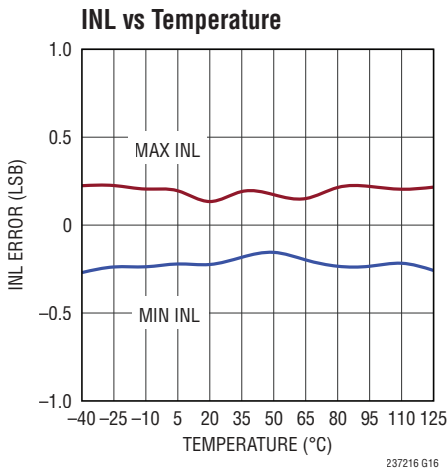
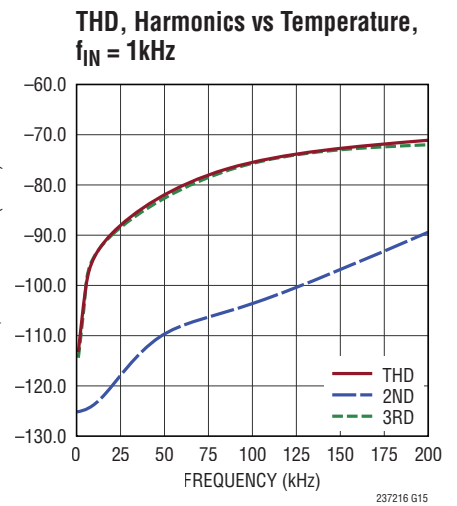
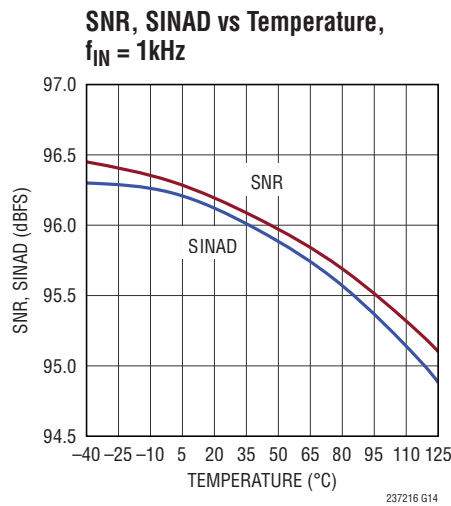
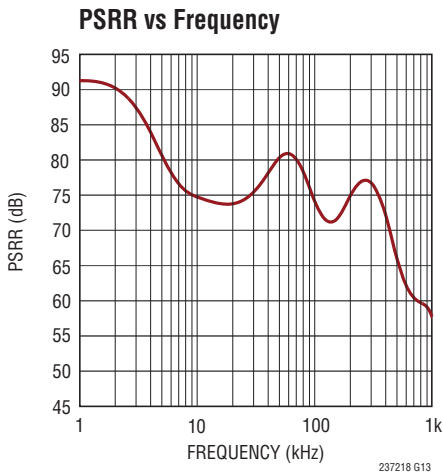
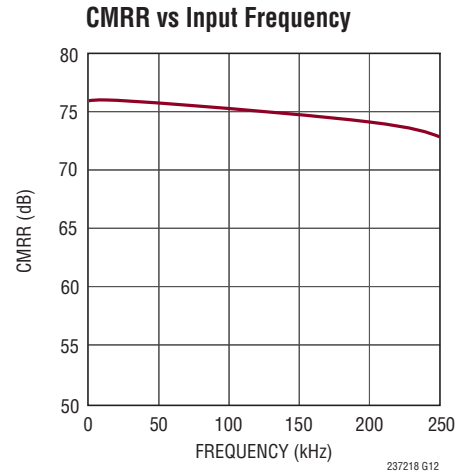
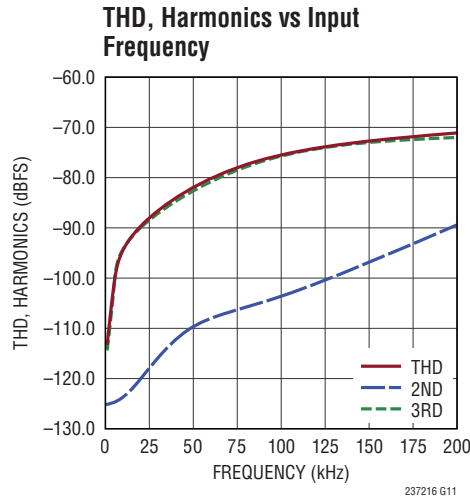
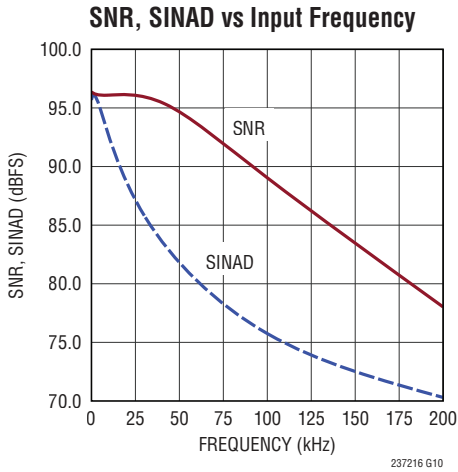
**SNR, SINAD vs Input Level,  $f_{IN} = 1\text{kHz}$**



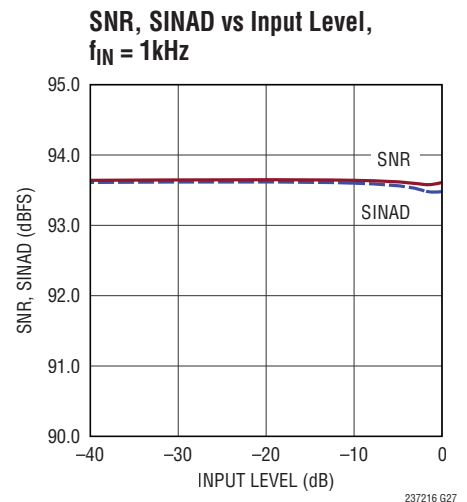
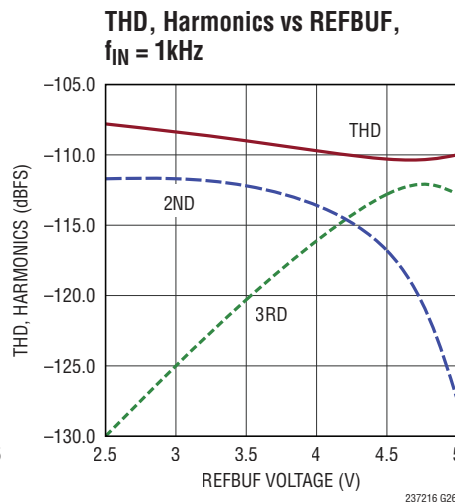
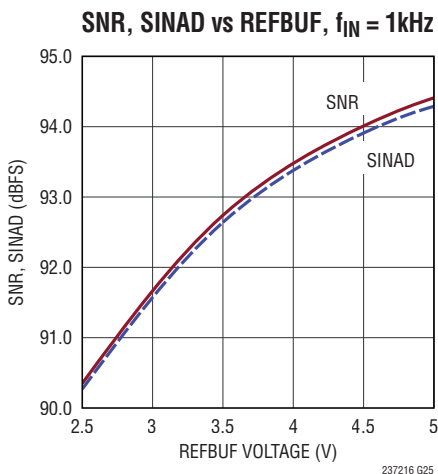
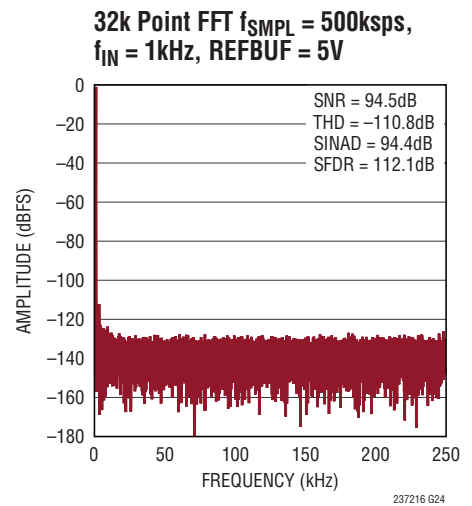
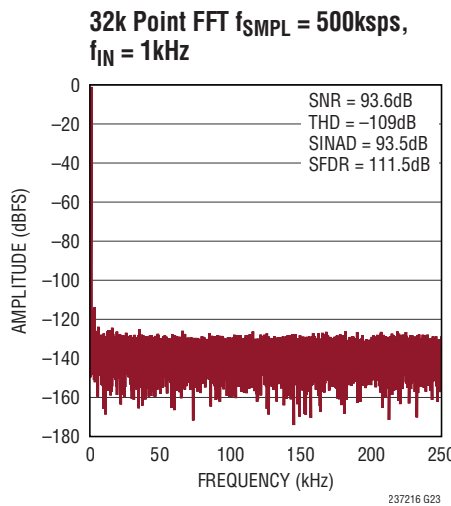
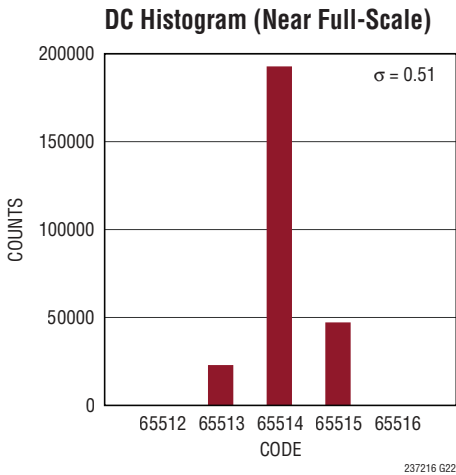
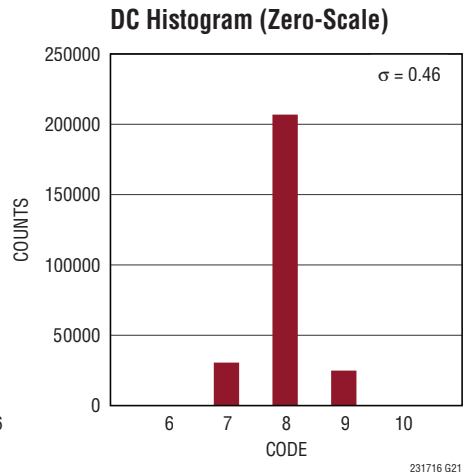
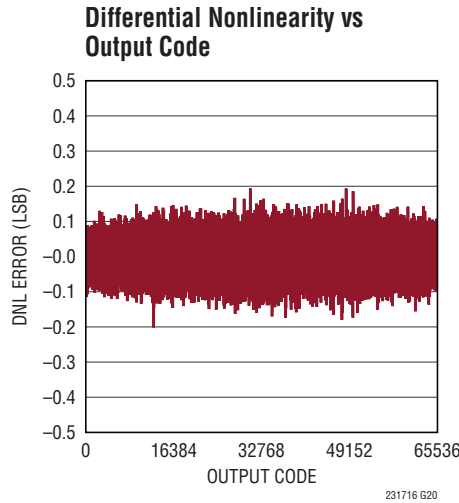
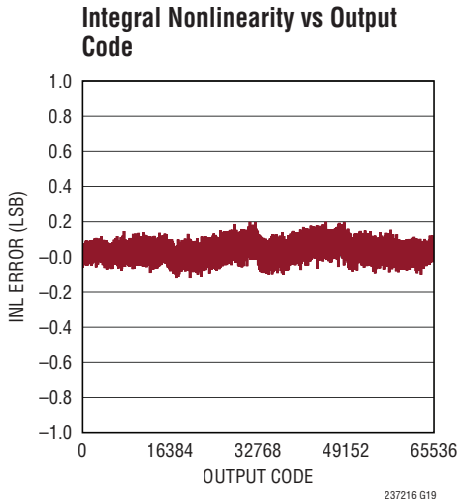
237216 G09

237216f

**TYPICAL PERFORMANCE CHARACTERISTICS**  $T_A = 25^\circ\text{C}$ ,  $V_{DD} = 5\text{V}$ ,  $OV_{DD} = 2.5\text{V}$ ,  $REF_{IN} = 2.048\text{V}$ , Fully Differential Range,  $V_{CM} = 2.048\text{V}$ ,  $f_{SAMPL} = 500\text{ksps}$ , unless otherwise noted.

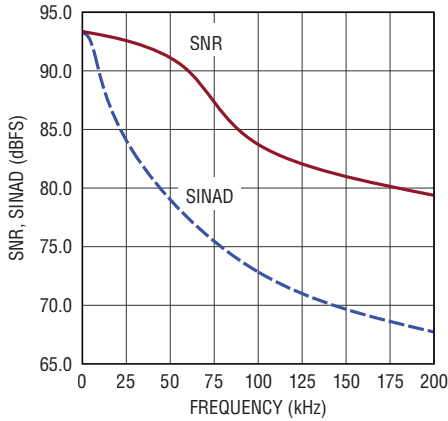


## TYPICAL PERFORMANCE CHARACTERISTICS $T_A = 25^\circ\text{C}$ , $V_{DD} = 5\text{V}$ , $0V_{DD} = 2.5\text{V}$ , $\text{REFIN} = 2.048\text{V}$ , Pseudo-Differential Unipolar Range, $f_{\text{SMPL}} = 500\text{kps}$ , unless otherwise noted.



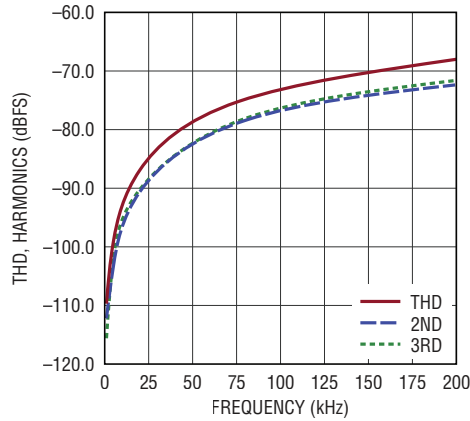
**TYPICAL PERFORMANCE CHARACTERISTICS**  $T_A = 25^\circ\text{C}$ ,  $V_{DD} = 5\text{V}$ ,  $OV_{DD} = 2.5\text{V}$ ,  $REF_{IN} = 2.048\text{V}$ , Pseudo-Differential Unipolar Range,  $f_{SAMPL} = 500\text{ksps}$ , unless otherwise noted.

**SNR, SINAD vs Input Frequency**



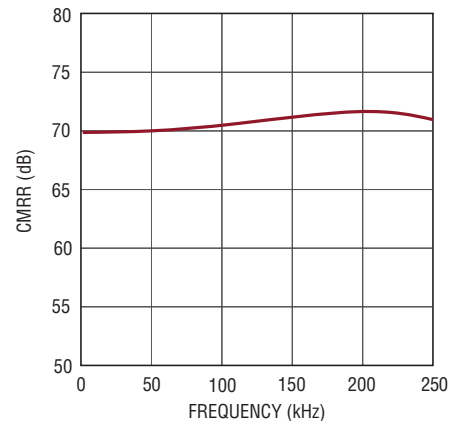
237216 G28

**THD, Harmonics vs Input Frequency**



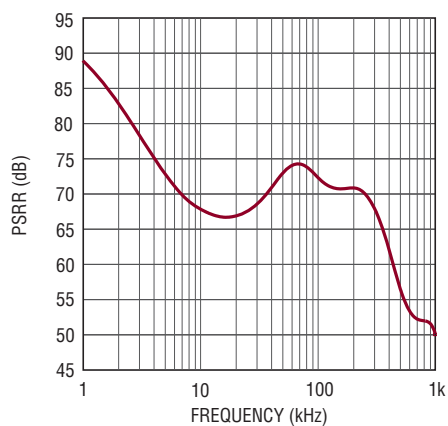
237216 G29

**CMRR vs Input Frequency**



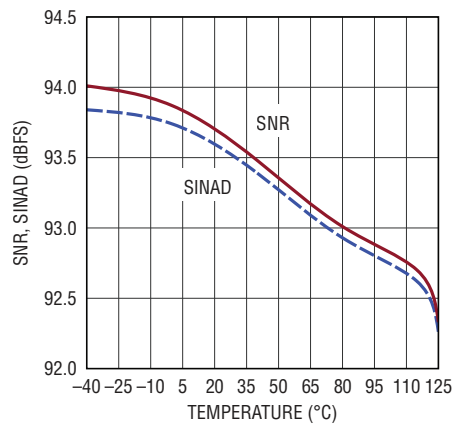
237218 G30

**PSRR vs Frequency**



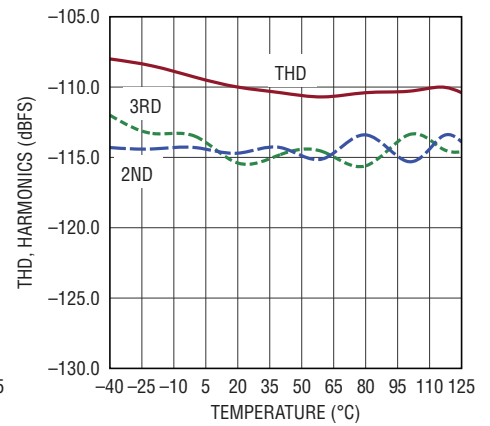
237218 G31

**SNR, SINAD vs Temperature,  $f_{IN} = 1\text{kHz}$**



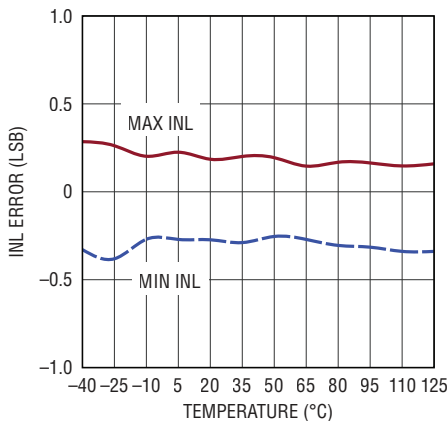
237216 G32

**THD, Harmonics vs Temperature,  $f_{IN} = 1\text{kHz}$**



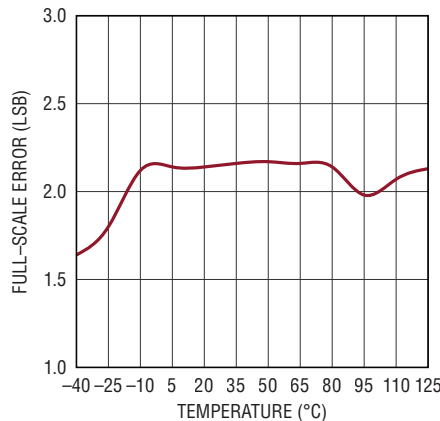
237216 G33

**INL vs Temperature**



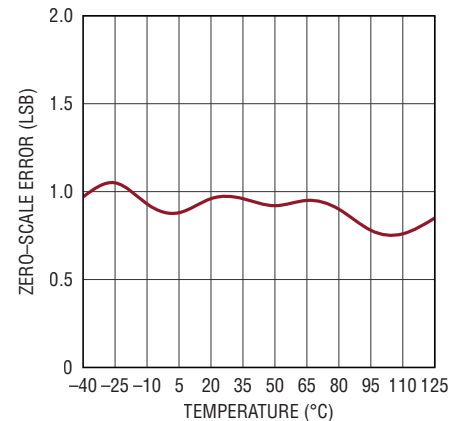
237216 G34

**Full-Scale Error vs Temperature  $REF_{BUF} = 4.096\text{V}$**



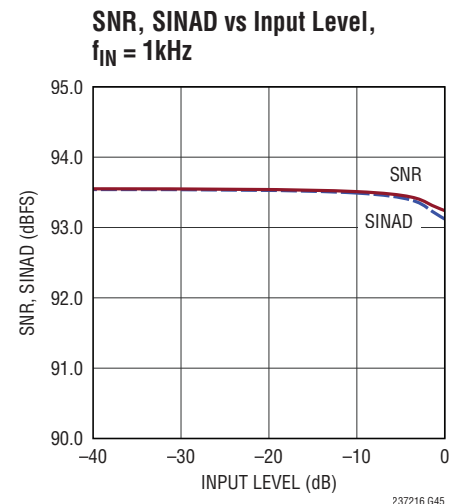
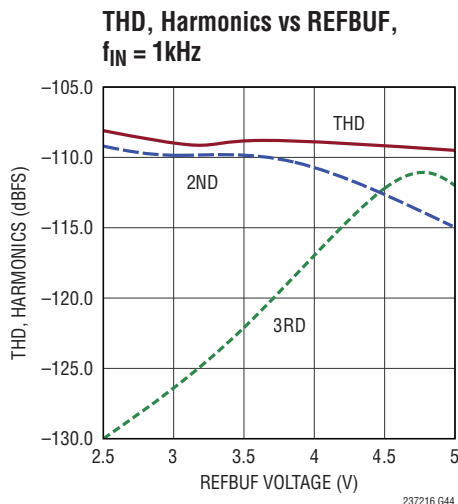
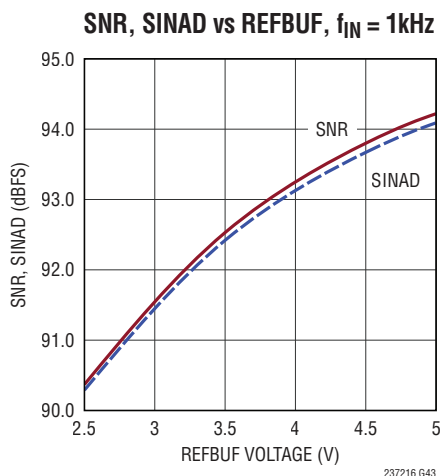
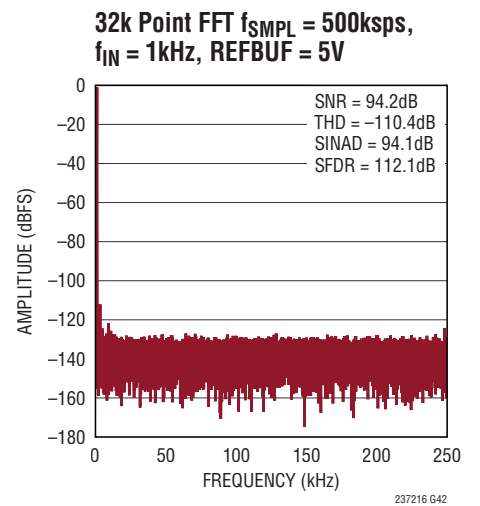
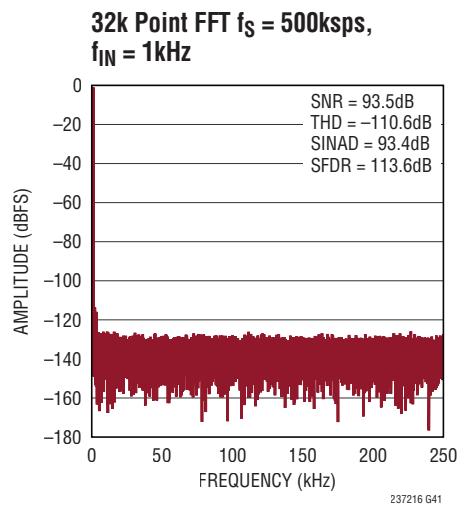
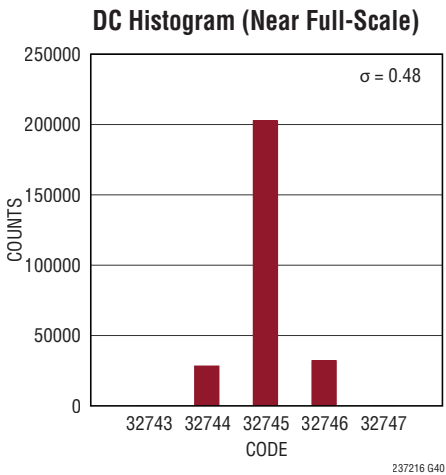
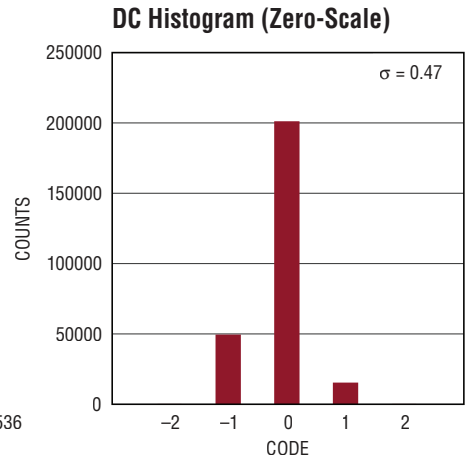
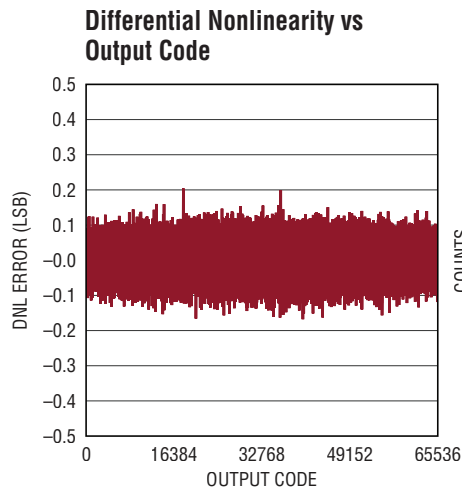
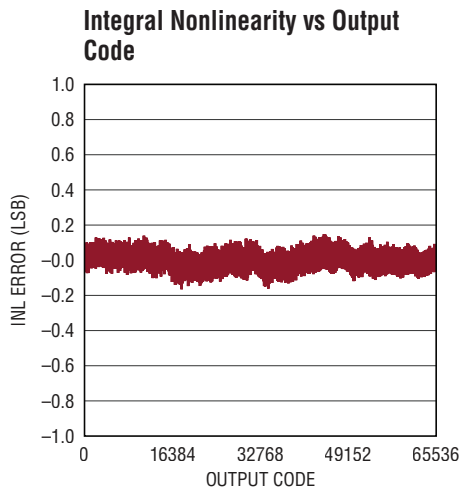
237216 G35

**Zero-Scale Error vs Temperature**

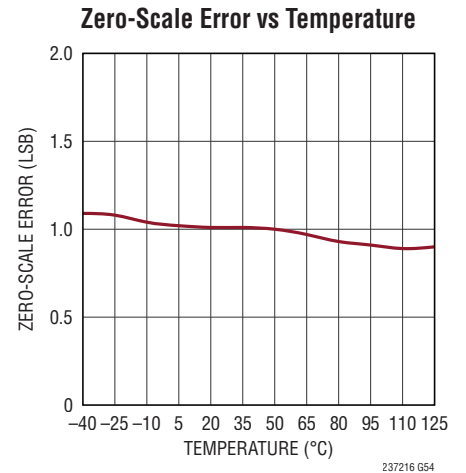
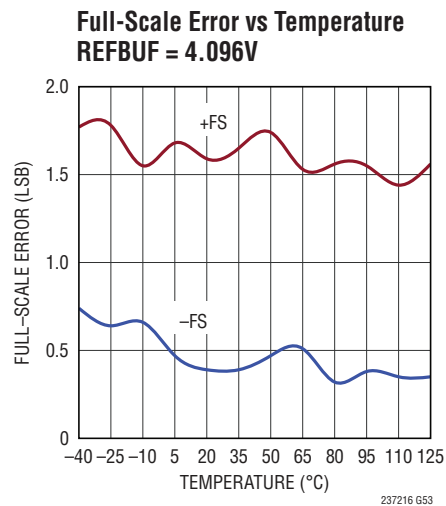
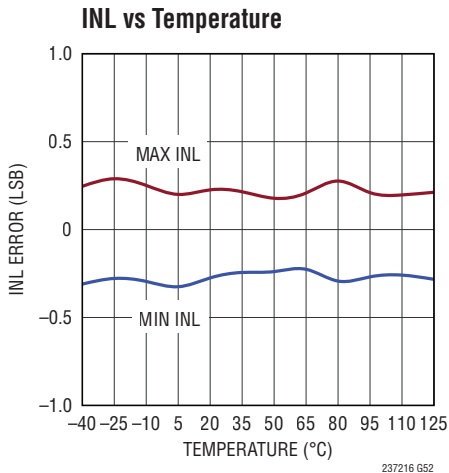
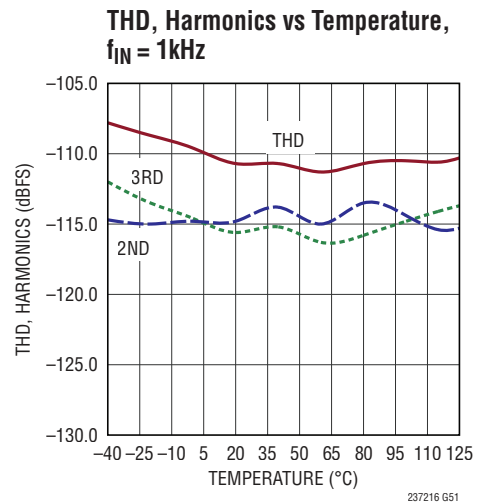
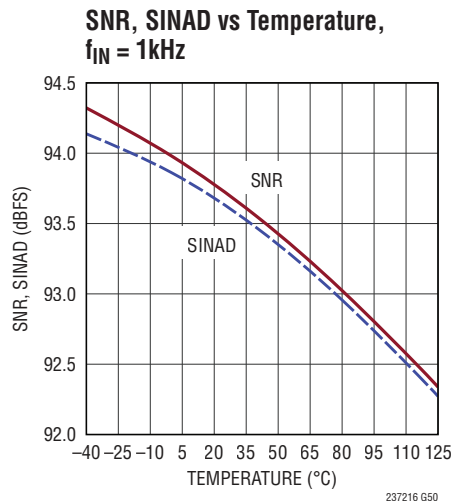
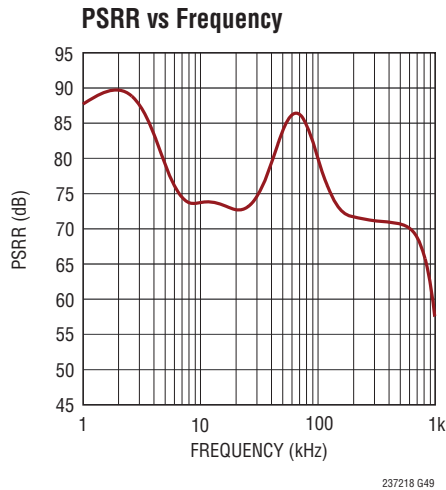
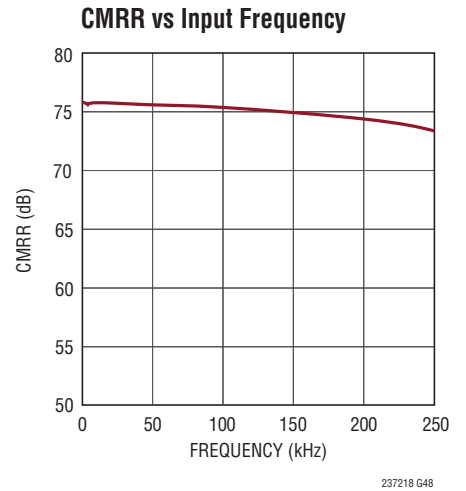
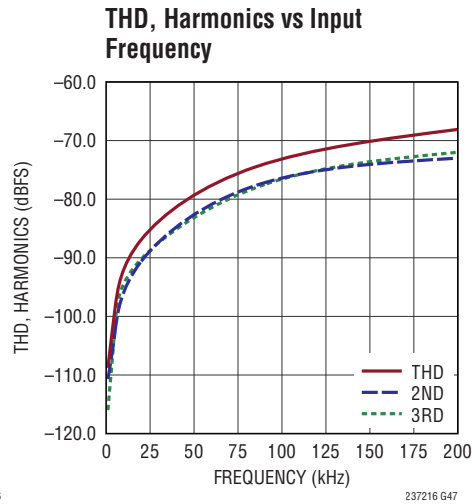
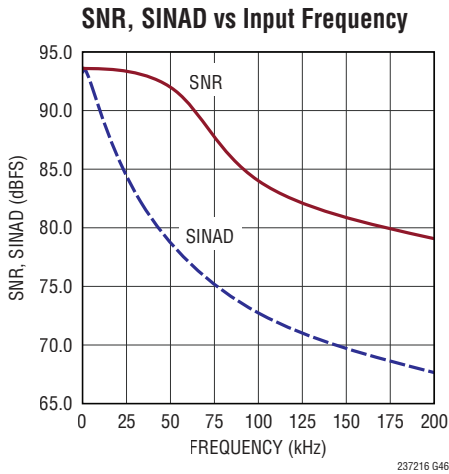


237216 G36

## TYPICAL PERFORMANCE CHARACTERISTICS $T_A = 25^\circ\text{C}$ , $V_{DD} = 5\text{V}$ , $OV_{DD} = 2.5\text{V}$ , $REF_{IN} = 2.048\text{V}$ , Pseudo-Differential Bipolar Range, $f_{\text{SMPL}} = 500\text{ksps}$ , unless otherwise noted.

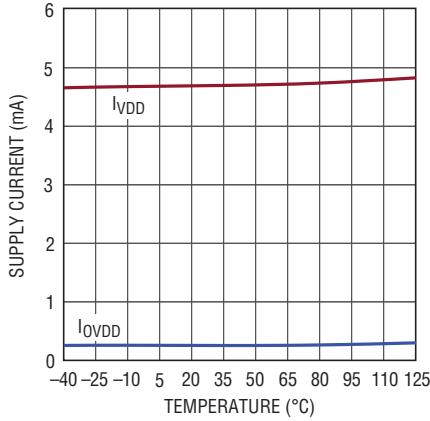


**TYPICAL PERFORMANCE CHARACTERISTICS**  $T_A = 25^\circ\text{C}$ ,  $V_{DD} = 5\text{V}$ ,  $OV_{DD} = 2.5\text{V}$ ,  $REF_{IN} = 2.048\text{V}$ , Pseudo-Differential Bipolar Range,  $f_{\text{SAMPL}} = 500\text{ksps}$ , unless otherwise noted.



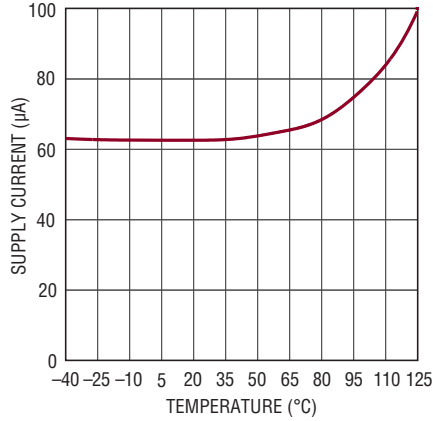
## TYPICAL PERFORMANCE CHARACTERISTICS $T_A = 25^\circ\text{C}$ , $V_{DD} = 5\text{V}$ , $OV_{DD} = 2.5\text{V}$ , $REF_{IN} = 2.048\text{V}$ , $f_{SAMPL} = 500\text{ksps}$ , unless otherwise noted.

**Supply Current vs Temperature**



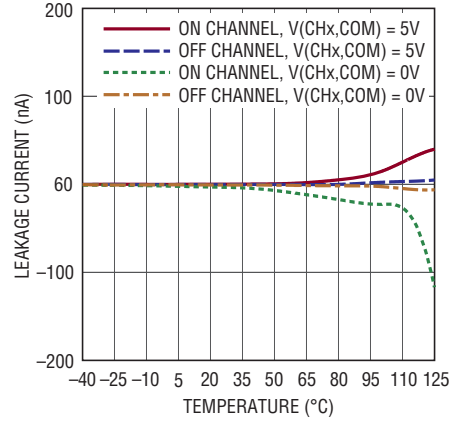
237218 G55

**Sleep Current vs Temperature**



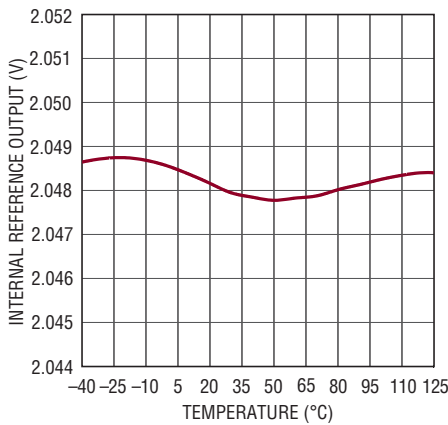
237218 G56

**Input Leakage Current vs Temperature (MUXOUT± Shorted to ADCIN±)**



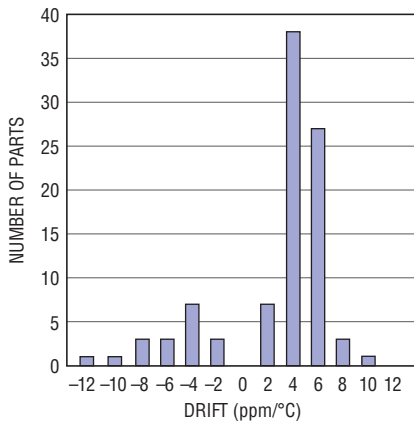
237218 G57

**Internal Reference Output vs Temperature**



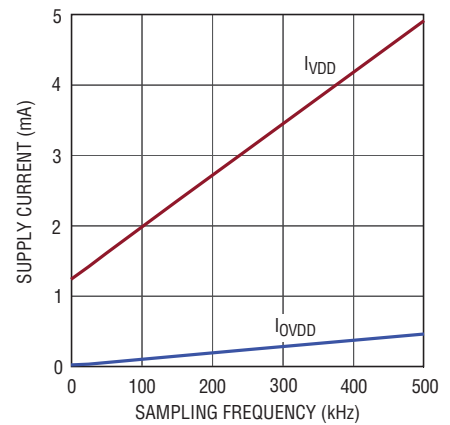
237218 G58

**Internal Reference Output Temperature Coefficient Distribution**



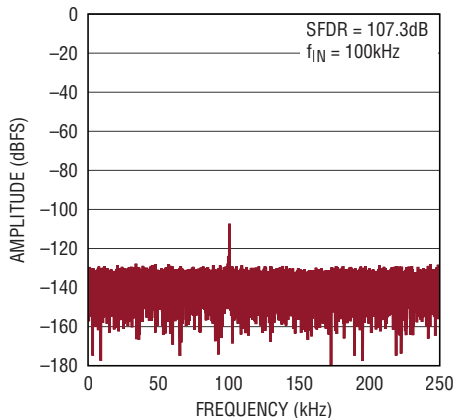
237218 G59

**Supply Current vs Sampling Rate**



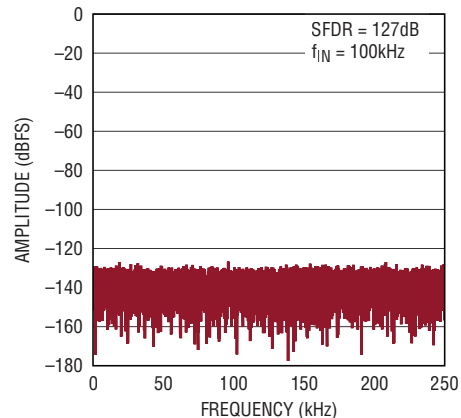
237218 G60

**Crosstalk FFT (AC Crosstalk-Channel Adjacent to MUXOUT)**



237216 G61

**Crosstalk FFT (AC Crosstalk-Channel NOT Adjacent to MUXOUT)**



237216 G62

## PIN FUNCTIONS

**CH0 to CH7 (Pins 1, 2, 7, 8, 9, 10, 31 and 32):** Analog Inputs. CH0 to CH7 can be configured as single-ended inputs relative to COM, or as pairs of differential input channels. See the Analog Input Multiplexer section. Unused analog inputs should be tied to a DC voltage within the analog input voltage range of (GND – 0.3V) to ( $V_{DD} + 0.3V$ ) as specified in Absolute Maximum Ratings.

**MUXOUT<sup>+</sup>, MUXOUT<sup>-</sup> (Pin 3, Pin 6):** Analog Output Pins of MUX.

**ADCIN<sup>+</sup>, ADCIN<sup>-</sup> (Pin 4, Pin 5):** Analog Input Pins of ADC Core.

**GND (Pins 11, 14, 15, 17, 23, 26, 27 and Exposed Pad Pin 33):** Ground.

**REFBUF (Pin 12):** Reference Buffer Output. An onboard buffer nominally outputs 4.096V to this pin. This pin is referred to GND and should be decoupled closely to the pin with a 47 $\mu$ F ceramic capacitor. The internal buffer driving this pin may be disabled by grounding its input at REFIN. Once the buffer is disabled, an external reference may overdrive this pin in the range of 2.5V to 5V. A resistive load greater than 500k can be placed on the reference buffer output.

**REFIN (Pin 13):** Reference Output/Reference Buffer Input. An onboard bandgap reference nominally outputs 2.048V at this pin. Bypass this pin with a 0.1 $\mu$ F ceramic capacitor to GND to limit the reference output noise. If more accuracy is desired, this pin may be overdriven by an external reference in the range of 1.25V to 2.4V.

**CNV (Pin 16):** Convert Input. A rising edge on this input powers up the part and initiates a new conversion. Logic levels are determined by  $OV_{DD}$ .

**RDL (Pin 18):** Read Low Input. When RDL is low, the serial data I/O bus is enabled. When RDL is high, the serial data I/O bus becomes Hi-Z. RDL also gates the external shift clock. Logic levels are determined by  $OV_{DD}$ .

**BUSY (Pin 19):** BUSY Indicator. Goes high at the start of a new conversion and returns low when the conversion has finished. Logic levels are determined by  $OV_{DD}$ .

**SDI (Pin 20):** Serial Data Input. Data provided on this pin in synchrony with SCK can be used to program the MUX channel configuration, converter input range and digital gain compression setting via the sequencer. Input data on SDI is latched on rising edges of SCK when the serial data I/O bus is enabled. Logic levels are determined by  $OV_{DD}$ .

**SCK (Pin 21):** Serial Data Clock Input. When the serial data I/O bus is enabled, the conversion result followed by configuration information is shifted out at SDO on the rising edges of this clock MSB first. Serial input data is latched on the rising edges of this clock at SDI. Logic levels are determined by  $OV_{DD}$ .

**SDO (Pin 22):** Serial Data Output. The conversion result followed by configuration information is output on this pin on each rising edge of SCK MSB first when the serial data I/O bus is enabled. The output data format is determined by the converter operating mode. Logic levels are determined by  $OV_{DD}$ .

**RESET (Pin 24):** Reset Input. When this pin is brought high, the LTC2372-16 is reset. If this occurs during a conversion, the conversion is halted and the data bus becomes Hi-Z. Logic levels are determined by  $OV_{DD}$ .

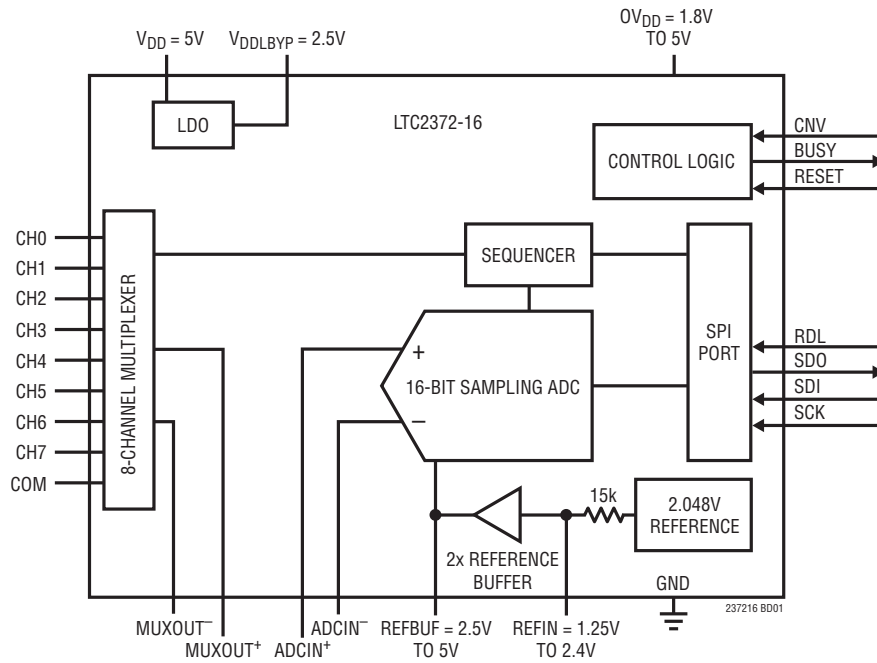
**$OV_{DD}$  (Pin 25):** I/O Interface Digital Power. The range of  $OV_{DD}$  is 1.71V to 5.25V. This supply is nominally set to the same supply as the host interface (1.8V, 2.5V, 3.3V, or 5V). Bypass  $OV_{DD}$  to GND with a 0.1 $\mu$ F capacitor.

**$V_{DDLBYP}$  (Pin 28):** 2.5V Supply Bypass Pin. The voltage on this pin is generated via an onboard regulator off of  $V_{DD}$ . This pin must be bypassed with a 2.2 $\mu$ F ceramic capacitor to GND. Applying an external voltage to this pin can cause damage to the IC or improper operation.

**$V_{DD}$  (Pin 29):** 5V Power Supply. The range of  $V_{DD}$  is 4.75V to 5.25V. Bypass  $V_{DD}$  to GND with a 10 $\mu$ F ceramic capacitor.

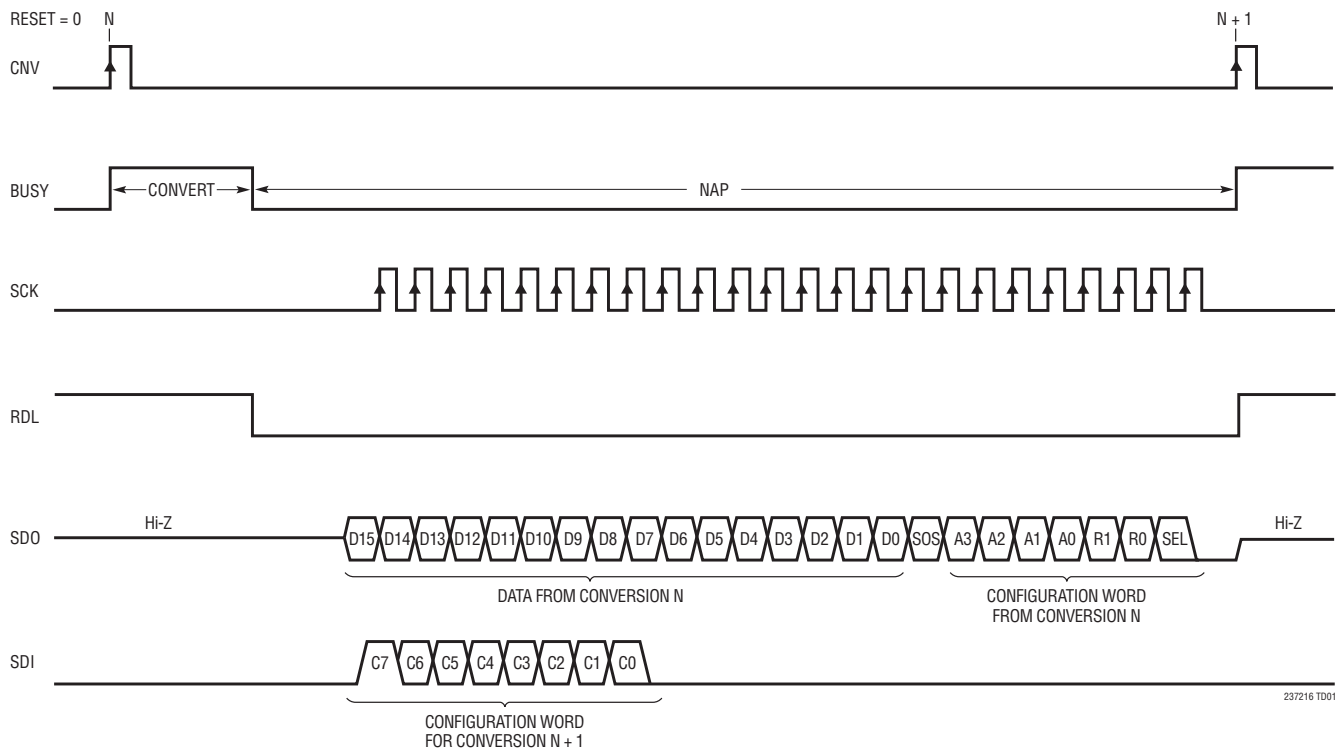
**COM (Pin 30):** Common Input. This is the reference point for all single-ended inputs. It must be free of noise and connected to GND for unipolar conversions and REFBUF/2 for bipolar conversions. If unused, this input should be tied to a DC voltage within the analog input voltage range of (GND – 0.3V) to ( $V_{DD} + 0.3V$ ) as specified in Absolute Maximum Ratings.

## FUNCTIONAL BLOCK DIAGRAM



## TIMING DIAGRAM

Typical Conversion and Serial Interface Timing



237216 TD01

237216f

## APPLICATIONS INFORMATION

### OVERVIEW

The LTC2372-16 is a low noise, high speed, highly configurable 8-channel 16-bit successive approximation register (SAR) ADC. The LTC2372-16 features a low crosstalk 8-channel input multiplexer (MUX) and a high performance 16-bit accurate ADC core that can be configured to accept fully-differential, pseudo-differential unipolar and pseudo-differential bipolar input signals. The input range of the ADC core can be set independently of the MUX input channel configuration. The outputs of the MUX and inputs of the ADC core are pinned out, allowing flexibility in how the MUX is connected to the ADC core. The MUX may be wired directly to the ADC core or signal conditioning circuitry may be inserted between the MUX and ADC core, depending on the application. The LTC2372-16 also has a selectable digital gain compression (DGC) feature. The LTC2372-16 has a programmable sequencer that can be programmed with configuration words ranging from a depth of one up to a maximum depth of 16 configuration words.

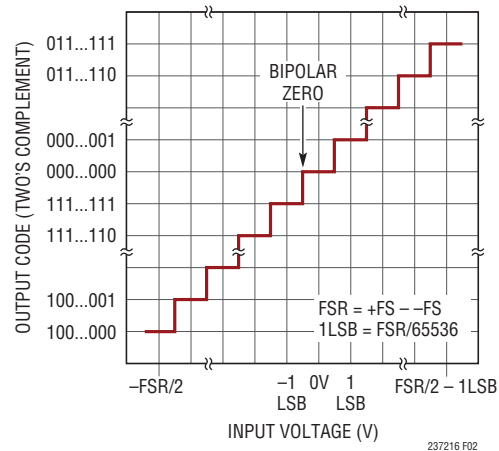
The LTC2372-16 has an onboard low drift reference and a single-shot capable reference buffer. The LTC2372-16 also has a high speed SPI-compatible serial interface that supports 1.8V, 2.5V, 3.3V and 5V logic. The LTC2372-16 automatically naps between conversions, leading to reduced power dissipation that scales with the sampling rate. A sleep mode is also provided for further power savings during inactive periods.

### CONVERTER OPERATION

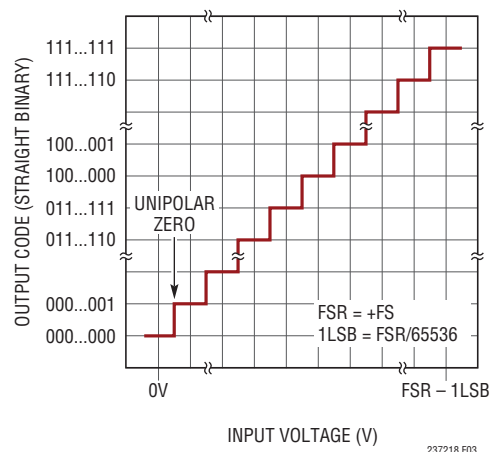
The LTC2372-16 operates in two phases. During the acquisition phase when MUXOUT<sup>+/-</sup> is wired to ADCIN<sup>+/-</sup>, the charge redistribution capacitor D/A converter (CDAC) is connected through the MUX to the selected MUX analog input pins. A rising edge on the CNV pin initiates a conversion. During the conversion phase, the 16-bit CDAC is sequenced through a successive approximation algorithm, effectively comparing the sampled input with binary-weighted fractions of the reference voltage (e.g.  $V_{REFBUF}/2$ ,  $V_{REFBUF}/4$  ...  $V_{REFBUF}/65536$ ) using a differential comparator. At the end of conversion, the CDAC output approximates the sampled analog input. The ADC control logic then prepares the 16-bit digital output code for serial transfer.

### TRANSFER FUNCTION

The LTC2372-16 digitizes the full-scale voltage of  $2 \times REFBUF$  in fully differential mode and  $REFBUF$  in pseudo-differential mode into  $2^{16}$  levels. With  $REFBUF = 4.096V$ , the resulting LSB sizes in fully differential and pseudo-differential modes are  $125\mu V$  and  $62.5\mu V$ , respectively. The binary format of the conversion result depends on the converter input range as described in Table 6. The ideal two's complement transfer function is shown in Figure 2, while the ideal straight binary transfer function is shown in Figure 3. The ideal straight binary transfer function can be obtained from the two's complement transfer function by inverting the most significant bit (MSB) of each output code.



**Figure 2. LTC2372-16 Two's Complement Transfer Function. Straight Binary Transfer Function Can Be Obtained by Inverting the Most Significant Bit (MSB) of Each Output Code**



**Figure 3. LTC2372-16 Straight Binary Transfer Function**

237216f

## APPLICATIONS INFORMATION

### ANALOG INPUTS

The LTC2372-16 can be configured to accept one of three voltage ranges: fully differential ( $\pm 4.096\text{V}$ ), pseudo-differential unipolar ( $0\text{V}$  to  $4.096\text{V}$ ), and pseudo-differential bipolar ( $\pm 2.048\text{V}$ ). In all three ranges, the ADC samples and digitizes the voltage difference between the two ADC core analog input pins ( $\text{ADCIN}^+ - \text{ADCIN}^-$ ), and any unwanted signal that is common to both inputs is reduced by the common mode rejection ratio (CMRR) of the ADC. The MUX outputs the voltages of the selected MUX analog input channels to  $\text{MUXOUT}^{+/-}$ , according to the MUX configuration.  $\text{MUXOUT}^{+/-}$  may be wired directly to  $\text{ADCIN}^{+/-}$  or connected through a buffer. Refer to the Configuring the LTC2372-16 section for details on how to select the analog input range and MUX channel configuration.

Independent of the selected range or channel configuration, the MUX analog inputs can be modeled by the equivalent circuit shown in Figure 4.  $\text{CH}_x$  and  $\text{CH}_y$  are distinct input pins selected from the  $\text{CH}_0$  to  $\text{CH}_7$  MUX analog inputs, depending on the MUX configuration. Each pin has ESD protection diodes. The ADC core analog inputs,  $\text{ADCIN}^{+/-}$ , each see a sampling network consisting of approximately  $50\text{pF}$  ( $\text{C}_{\text{IN}}$ ) from the sampling CDAC in series with  $40\Omega$  ( $\text{R}_{\text{ON}}$ ) from the on-resistance of the sampling switch. The MUX is modeled by a  $40\Omega$  resistor representing the MUX switch on-resistance ( $\text{R}_{\text{SW}}$ ) and a capacitance to

ground,  $\text{C}_{\text{PAR}}$ , at the output summing node of the MUX.  $\text{C}_{\text{PAR}}$  is a lumped capacitance on the order of  $20\text{pF}$  formed primarily by pin parasitics and diode junctions. Parasitic capacitances from the PCB will also contribute to  $\text{C}_{\text{PAR}}$ . This capacitance is discharged through a switch to ground every conversion cycle or when a first new configuration is programmed to minimize crosstalk due to charge sharing between channels.

During acquisition, each active MUX analog input sees a cascade of two first order lowpass filters formed by  $\text{R}_{\text{SW}}$ ,  $\text{C}_{\text{PAR}}$  and the ADC sampling network when  $\text{MUXOUT}^{+/-}$  is wired directly to  $\text{ADCIN}^{+/-}$ . If a buffer is inserted between  $\text{MUXOUT}^{+/-}$  and  $\text{ADCIN}^{+/-}$ , then each active MUX analog input only sees a first order lowpass filter formed by  $\text{R}_{\text{SW}}$  and  $\text{C}_{\text{PAR}}$  that is loaded with the input impedance of the buffer.

Both  $\text{C}_{\text{IN}}$  and  $\text{C}_{\text{PAR}}$  draw current spikes while being charged during acquisition. If  $\text{MUXOUT}^{+/-}$  is wired directly to  $\text{ADCIN}^{+/-}$ , the current spikes from the charging of both capacitors are drawn from the active MUX analog inputs. A buffer inserted between  $\text{MUXOUT}^{+/-}$  and  $\text{ADCIN}^{+/-}$  will absorb the current spike from  $\text{C}_{\text{IN}}$ , leaving the current spike from  $\text{C}_{\text{PAR}}$  to be drawn from the active MUX analog inputs. During conversion and sleep, the MUX analog inputs and ADC core analog inputs draw only a small leakage current.

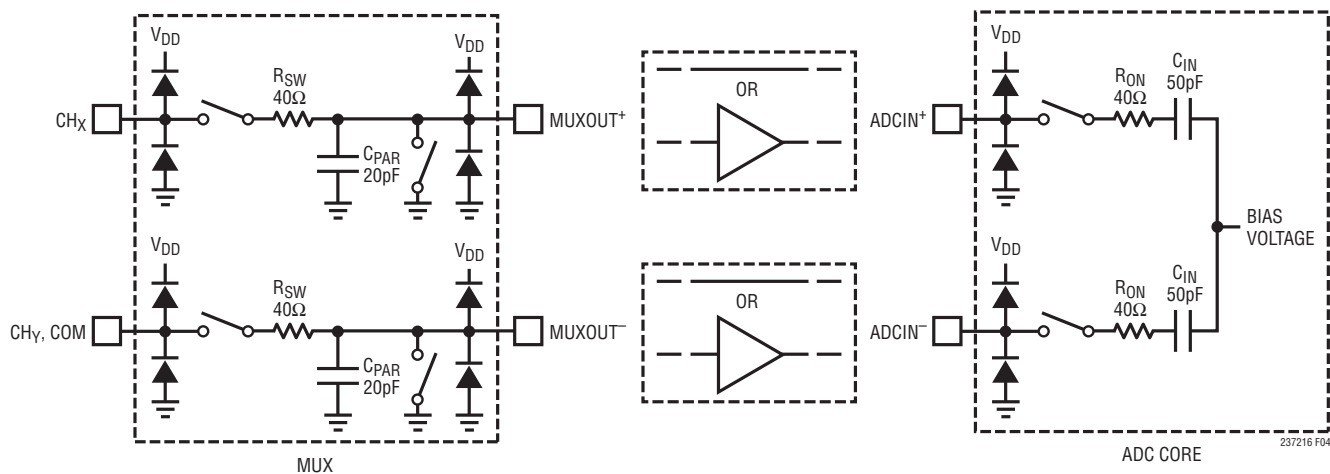


Figure 4. Equivalent Circuit for the Differential Analog Inputs of the LTC2372-16

## APPLICATIONS INFORMATION

### Fully Differential Input Range

The fully differential input range provides the widest input signal swing, configuring the ADC to digitize the differential analog input voltage to the ADC core ( $ADCIN^+ - ADCIN^-$ ) provided through the selected MUX analog inputs over a span of  $\pm V_{REFBUF}$ . In this range, the  $ADCIN^+$  and  $ADCIN^-$  pins should be driven 180 degrees out-of-phase with respect to each other, centered around a common mode voltage  $(ADCIN^+ + ADCIN^-)/2$  that is restricted to  $(V_{REFBUF}/2 \pm 0.1V)$ . Both the  $ADCIN^+$  and  $ADCIN^-$  pins are allowed to swing from  $(GND - 0.1V)$  to  $(V_{REFBUF} + 0.1V)$ . Unwanted signals common to both inputs are reduced by the CMRR of the ADC. The output data format may be selected as straight binary or two's complement.

### Pseudo-Differential Unipolar Input Range

In the pseudo-differential unipolar input range, the ADC digitizes the differential analog input voltage to the ADC core ( $ADCIN^+ - ADCIN^-$ ) provided through the selected MUX analog inputs over a span of  $(0V \text{ to } V_{REFBUF})$ . In this range, a single-ended unipolar input signal, driven on the  $ADCIN^+$  pin, is measured with respect to the signal ground reference level, driven on the  $ADCIN^-$  pin. The  $ADCIN^+$  pin is allowed to swing from  $(GND - 0.1V)$  to  $(V_{REFBUF} + 0.1V)$ , while the  $ADCIN^-$  pin is restricted to  $(GND \pm 0.1V)$ . Unwanted signals common to both inputs are reduced by the CMRR of the ADC. The output data format is straight binary.

### Pseudo-Differential Bipolar Input Range

In the pseudo-differential bipolar input range, the ADC digitizes the differential analog input voltage to the ADC core ( $ADCIN^+ - ADCIN^-$ ) provided through the selected MUX analog inputs over a span of  $(\pm V_{REFBUF}/2)$ . In this range, a single-ended bipolar input signal, driven on the  $ADCIN^+$  pin, is measured with respect to the signal mid-scale reference level, driven on the  $ADCIN^-$  pin. The  $ADCIN^+$  pin is allowed to swing from  $(GND - 0.1V)$  to  $(V_{REFBUF} + 0.1V)$ , while the  $ADCIN^-$  pin is restricted to  $(V_{REFBUF}/2 \pm 0.1V)$ . Unwanted signals common to both inputs are reduced by the CMRR of the ADC. The output data format is two's complement.

### INPUT DRIVE CIRCUITS

Whether  $MUXOUT^{+/-}$  is wired directly to  $ADCIN^{+/-}$  or through a buffer with high input impedance, the MUX analog inputs of the LTC2372-16 are high impedance. In either case, a low impedance source can directly drive the MUX analog inputs without gain error. A high impedance source should be buffered in both cases to minimize settling time during acquisition and to optimize ADC linearity.

For best performance, a buffer amplifier should be used to drive the MUX analog inputs of the LTC2372-16 with  $MUXOUT^{+/-}$  wired directly to  $ADCIN^{+/-}$ . The amplifier provides low output impedance, which produces fast settling of the analog signal during the acquisition phase. It also provides isolation between the signal source and the current spikes drawn by the MUX analog inputs when entering acquisition.

### Noise and Distortion

The noise and distortion of the buffer amplifiers and signal sources must be considered since they add to the ADC noise and distortion. Noisy input signals should be filtered prior to the inputs of the buffers driving the MUX analog inputs with an appropriate filter to minimize noise. The simple 1-pole RC lowpass filter (LPF1) shown in Figure 5 is sufficient for many applications.

Buffer amplifiers with low noise density must be selected to minimize SNR degradation. Coupling filter networks (LPF2) should be placed between the buffer outputs and MUX analog inputs to both minimize the noise contribution of the buffers and reduce disturbances reflected into the buffer from MUX analog input sampling transients. If a buffer amplifier is used between  $MUXOUT^{+/-}$  and  $ADCIN^{+/-}$ , a coupling filter network (LPF3) should be placed between the buffer output and ADC core analog inputs to both minimize the noise contribution of the buffer and reduce disturbances reflected into the buffer from the ADC core analog input sampling transients. Long RC time constants at the MUX or ADC core analog inputs will slow down the settling of those inputs. Therefore, LPF2 and LPF3 typically require wider bandwidths than LPF1.

## APPLICATIONS INFORMATION

Table 1 lists typical recommended values for the R and C of each LPF mentioned.

**Table 1. Recommended R and C Values for Each Lowpass Filter**

	Rx( $\Omega$ )	Cx(pF)	BANDWIDTH
LPF1	50	100000	31.8kHz
LPF2	10	1200	13MHz
LPF3	25	2700	2.4MHz

High quality capacitors and resistors should be used in the RC filters since these components can add distortion. NPO and silver mica type dielectric capacitors have excellent linearity. Carbon surface mount resistors can generate distortion from self heating and from damage that may occur during soldering. Metal film surface mount resistors are much less susceptible to both problems.

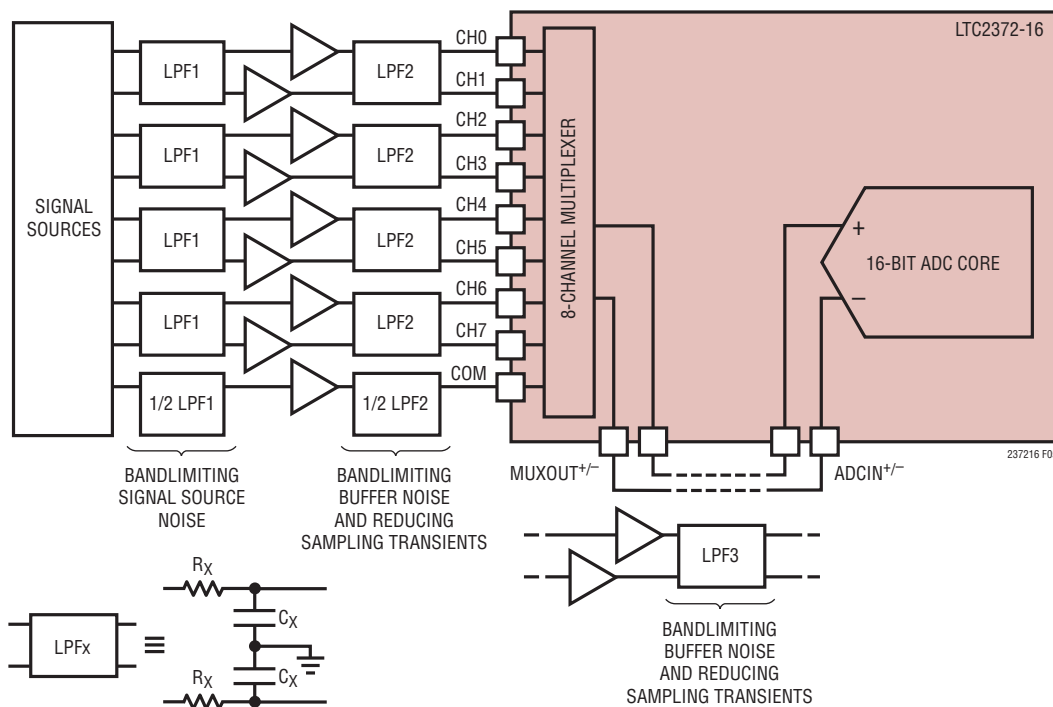
### Input Currents

One of the biggest challenges in coupling an amplifier to the LTC2372-16 is in dealing with current spikes drawn by the MUX and ADC core analog inputs at the start of each acquisition phase. LPF2 and LPF3 are examples of

coupling filters that are used to both filter noise and reduce sampling transients due to the current spikes.

The MUX and ADC core analog inputs may be modeled as a switched capacitor load on the drive circuit. A drive circuit may rely partially on attenuating switched-capacitor current spikes with small filter capacitors  $C_{\text{FILT}}$  placed directly at the ADC inputs and partially on the driver amplifier having sufficient bandwidth to recover from the residual disturbance. Amplifiers optimized for DC performance may not have sufficient bandwidth to fully recover at the ADC's maximum conversion rate, which can produce nonlinearity and other errors. Coupling filter circuits may be classified in three broad categories:

*Fully Settled:* This case is characterized by filter time constants and an overall settling time that are considerably shorter than the sample period. When acquisition begins, the coupling filter is disturbed. For a typical first order RC filter, the disturbance will look like an initial step with an exponential decay. The amplifier will have its own response to the disturbance, which may include ringing. If the input settles completely (to within the accuracy of the LTC2372-16), the disturbance will not contribute any error.



**Figure 5. Input Signal Chain**

237216f

## APPLICATIONS INFORMATION

**Partially Settled:** In this case, the beginning of acquisition causes a disturbance of the coupling filter, which then begins to settle out towards the nominal input voltage. However, acquisition ends (and the conversion begins) before the input settles to its final value. This generally produces a gain error, but as long as the settling is linear, no distortion is produced. The coupling filter's response is affected by the amplifier's output impedance and other parameters. A linear settling response to fast switched-capacitor current spikes can NOT always be assumed for precision, low bandwidth amplifiers. The coupling filter serves to attenuate the current spikes' high frequency energy before it reaches the amplifier.

**Fully Averaged:** Consider the case where MUXOUT<sup>+/-</sup> is directly wired to ADCIN<sup>+/-</sup>. If the coupling filter's capacitors (C<sub>FILT</sub>) at the MUX analog inputs are much larger than the sum of the ADC's sample capacitors (50pF) and the MUX's output summing node capacitances (20pF), then the sampling glitch is greatly attenuated. The driving amplifier effectively only sees the average sampling current, which is quite small. At 500ksps, the equivalent input resistance is approximately 28k (as shown in Figure 6), a benign resistive load for most precision amplifiers. However, resistive voltage division will occur between the coupling filter's DC resistance and MUX's equivalent (switched-capacitor) input resistance, thus producing a gain error.

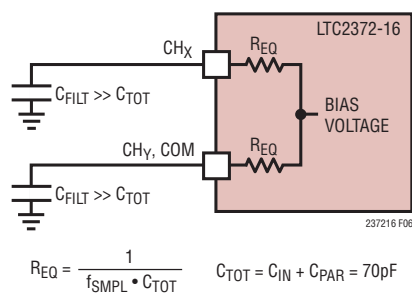


Figure 6. Equivalent Circuit for the MUX Analog Inputs of the LTC2372-16 at 500ksps

### Crosstalk

Crosstalk is a typical concern in systems that employ multiplexers. The LTC2372-16 features a low crosstalk 8-channel MUX. There are two forms of crosstalk in the LTC2372-16 that potentially allow the signal from one channel to corrupt the signal from another channel being sampled.

The first form of crosstalk is often referred to as static crosstalk. In static crosstalk, a signal applied to an OFF channel, V<sub>INTERFERER</sub>, couples capacitively into the input signal path, thus corrupting the input signal of the ON channel, V<sub>SIGNAL</sub>. Figure 7 shows an RC model of two MUX input channels and the associated parasitic capacitances. Capacitive coupling from an OFF channel into the input signal path can occur through C<sub>SW</sub> of an OFF switch to the MUXOUT<sup>+/-</sup> output pins or through C<sub>PIN</sub> to an adjacent input pin or the MUXOUT<sup>+/-</sup> output pins. Coupling through C<sub>PIN</sub> to the MUXOUT<sup>+/-</sup> pins is the dominant coupling mechanism that limits the crosstalk to -107dB with a 100kHz input signal applied to an OFF CH3 or CH4. These pins sit adjacent to the MUXOUT<sup>+</sup> and MUXOUT<sup>-</sup> pins, respectively.

The second form of crosstalk is referred to as adjacent channel crosstalk, which has to do with memory from the input of one channel affecting the sampled value of another channel. In this case, C<sub>PAR</sub> at the output summing nodes of the MUX, MUXOUT<sup>+/-</sup>, can act as memory storage elements if not dealt with properly. The potential crosstalk mechanism here is through charge sharing. C<sub>PAR</sub> is charged approximately to the voltage of each channel that is sampled. If that charge is not cleared when switching from one channel to the next, then charge sharing between the charge on the filter capacitor (C<sub>FILT</sub>) of one channel will occur with the charge from another channel stored on C<sub>PAR</sub>. The unwanted charge from C<sub>PAR</sub> can take a long time to settle out depending on the input filter bandwidth. C<sub>PAR</sub> is discharged through a low impedance switch to ground every conversion cycle or when a first new configuration is programmed to mitigate this effect.

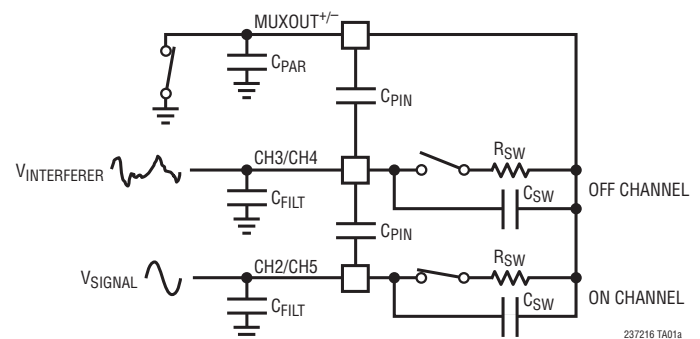


Figure 7. RC Equivalent Circuit for Two MUX Analog Input Channels

237216f

## APPLICATIONS INFORMATION

### Driving the MUX Analog Inputs

The LTC2372-16 can be programmed to accept fully differential or pseudo-differential input signals. In most applications, it is recommended that the LTC2372-16 be driven using the LT6237 ADC driver configured as two unity-gain buffers regardless of the input range, as shown in Figure 8a. The LT6237 combines fast settling and good DC linearity with a  $1.1\text{nV}/\sqrt{\text{Hz}}$  input-referred noise den-

sity, enabling it to achieve the full ADC data sheet SNR and THD specifications for all input ranges, as shown in the FFT plots in Figures 8b, 8c and 8d. The RC filter time constant is chosen to allow for sufficient transient settling of the LTC2372-16 MUX analog inputs during acquisition. With a maximum supply current of 7.8mA, the LT6237 is a perfect complement to the low power LTC2372-16.

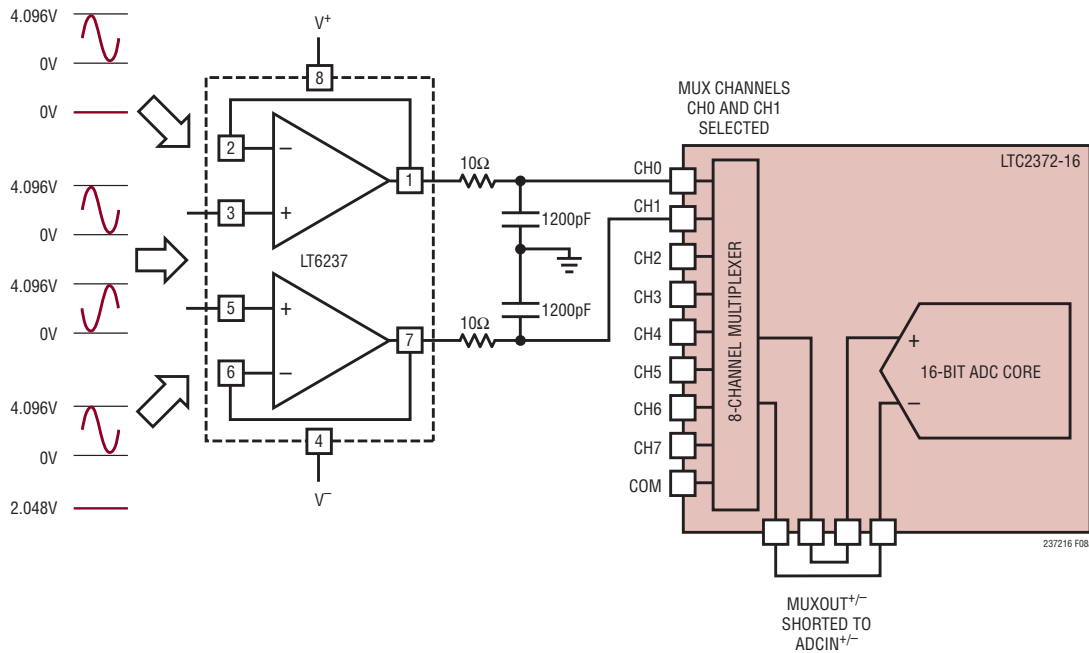


Figure 8a. LT6237 Buffering a Fully Differential or Pseudo-Differential Signal Source

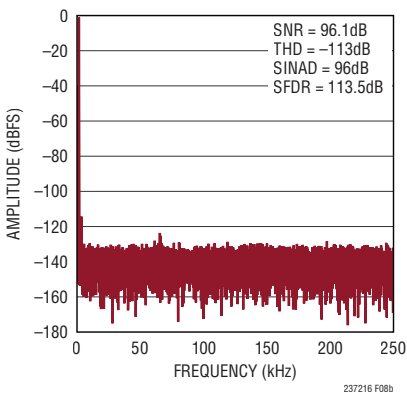


Figure 8b. 32k Point FFT  $f_{\text{SMPL}} = 500\text{kpsps}$ ,  $f_{\text{IN}} = 1\text{kHz}$  for Circuit Shown in Figure 8a; Driven with Fully Differential Inputs

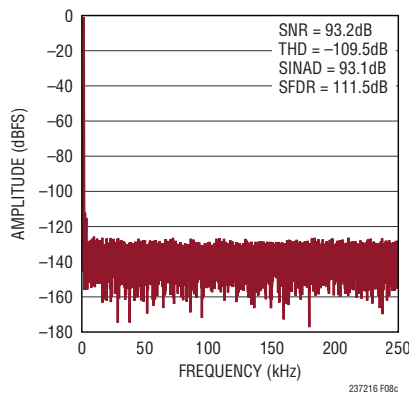


Figure 8c. 32k Point FFT  $f_{\text{SMPL}} = 500\text{kpsps}$ ,  $f_{\text{IN}} = 1\text{kHz}$  for Circuit Shown in Figure 8a; Driven with Unipolar Inputs

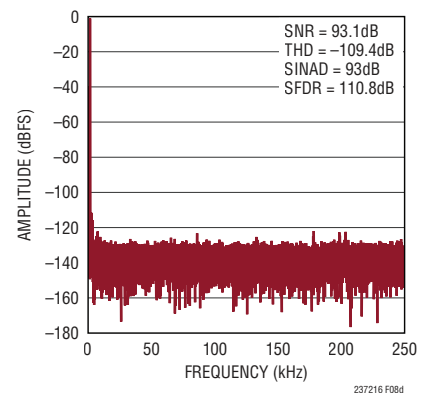


Figure 8d. 32k Point FFT  $f_{\text{SMPL}} = 500\text{kpsps}$ ,  $f_{\text{IN}} = 1\text{kHz}$  for Circuit Shown in Figure 8a; Driven with Bipolar Inputs

## APPLICATIONS INFORMATION

### Maximizing SNR with a Single-Ended to Differential Conversion

A single-ended input signal may be converted to a fully differential signal prior to driving the MUX analog inputs of the LTC2372-16 to take advantage of the higher SNR of the LTC2372-16 in the fully differential input range. The LT6350 ADC driver shown in Figure 9a can be used to convert a 0V to 4.096V input signal to a fully differential  $\pm 4.096V$  output signal. The RC time constant is larger in this case to limit the high frequency noise contribution of the LT6350. This topology provides a 2.5dB increase in SNR over single-ended operation and achieves the full data sheet SNR performance of the fully differential input range of 96dB as shown in the FFT plot in Figure 9b. The maximum supply current of 10.4mA makes the LT6350 a good companion to the low power LTC2372-16.

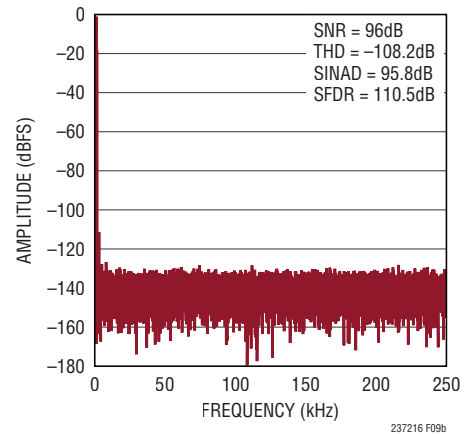


Figure 9b. 32k Point FFT  $f_{\text{SMPL}} = 500\text{kpsps}$ ,  $f_{\text{IN}} = 1\text{kHz}$  for Circuit Shown in Figure 9a

### Maximizing SNR for Eight Single-Ended Inputs Using a Shared Amplifier Between MUXOUT $^{+/-}$ and ADCIN $^{+/-}$

While converting a single-ended signal to a fully differential signal offers the benefit of higher SNR, two input channels are required per single-ended input, leading to a reduced number of single-ended input signals that can be interfaced to the LTC2372-16. Performing the single-ended to differential conversion using the LT6237

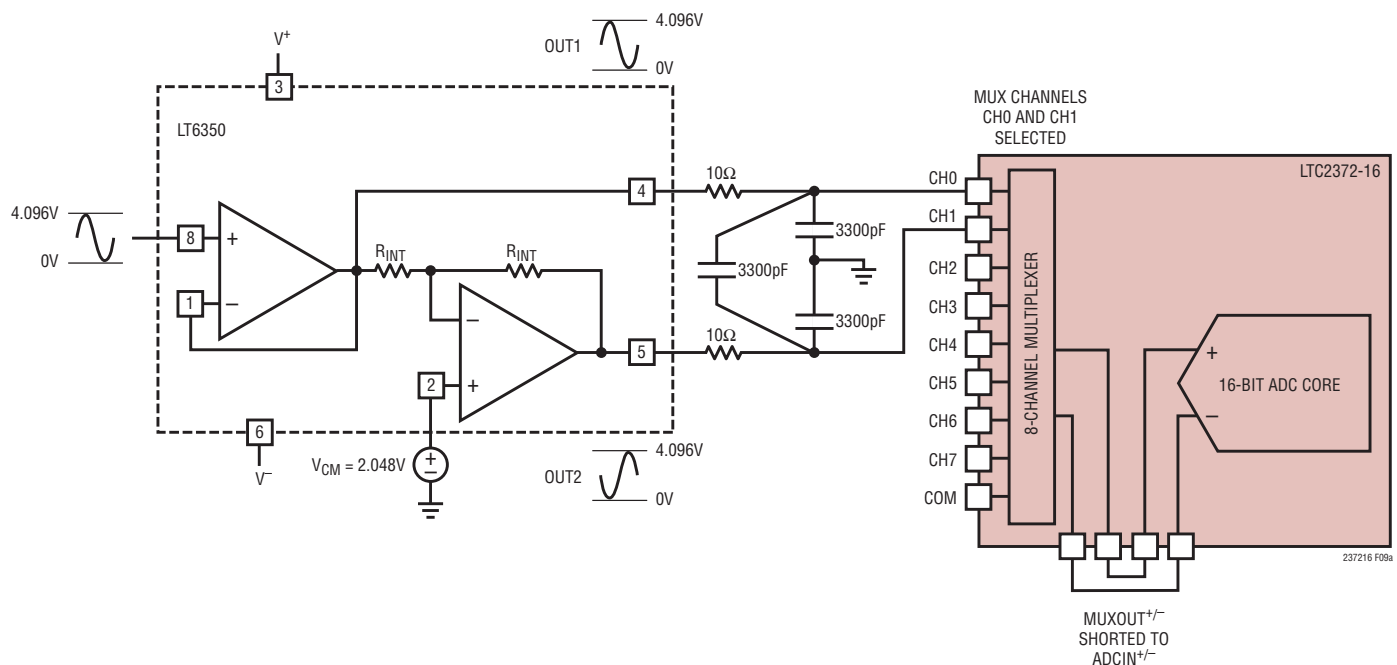


Figure 9a. LT6350 Converting a 0V to 4.096V Single-Ended Signal to a  $\pm 4.096V$  Fully Differential Signal

## APPLICATIONS INFORMATION

between MUXOUT<sup>+/-</sup> and ADCIN<sup>+/-</sup> as shown in Figure 10a provides the SNR benefits of the fully differential range without sacrificing additional MUX inputs to do so. Using the MUX configurations where CH0 to CH7 is output to MUXOUT<sup>+</sup> and COM to MUXOUT<sup>-</sup> enables eight single-ended inputs to be converted with the fully differential input range. The COM MUX input channel is used in the feedback connection of the buffer amplifier connected in a follower configuration to improve the distortion performance of the circuit. THD degradation would otherwise occur due to the non-linear voltage drop across the MUX switch from the input current of the buffer and the non-linear on-resistance of the MUX switch. The 1k resistor between COM and MUXOUT<sup>-</sup> maintains negative feedback around the buffer when the MUX turns OFF, so that the buffer output does not rail. Eight single-ended

inputs achieve an SNR of 96dB with this circuit as shown in Figure 10b, which is a 2.5dB improvement in SNR over single-ended operation.

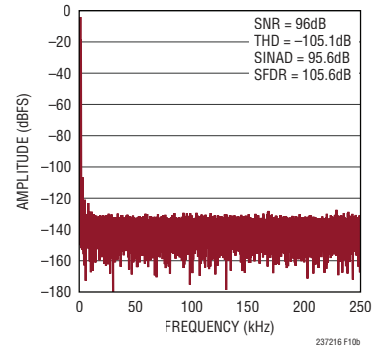


Figure 10b. 32k Point FFT  $f_{SAMPL} = 500ksps$ ,  $f_{IN} = 1kHz$  for Circuit Shown in Figure 10a

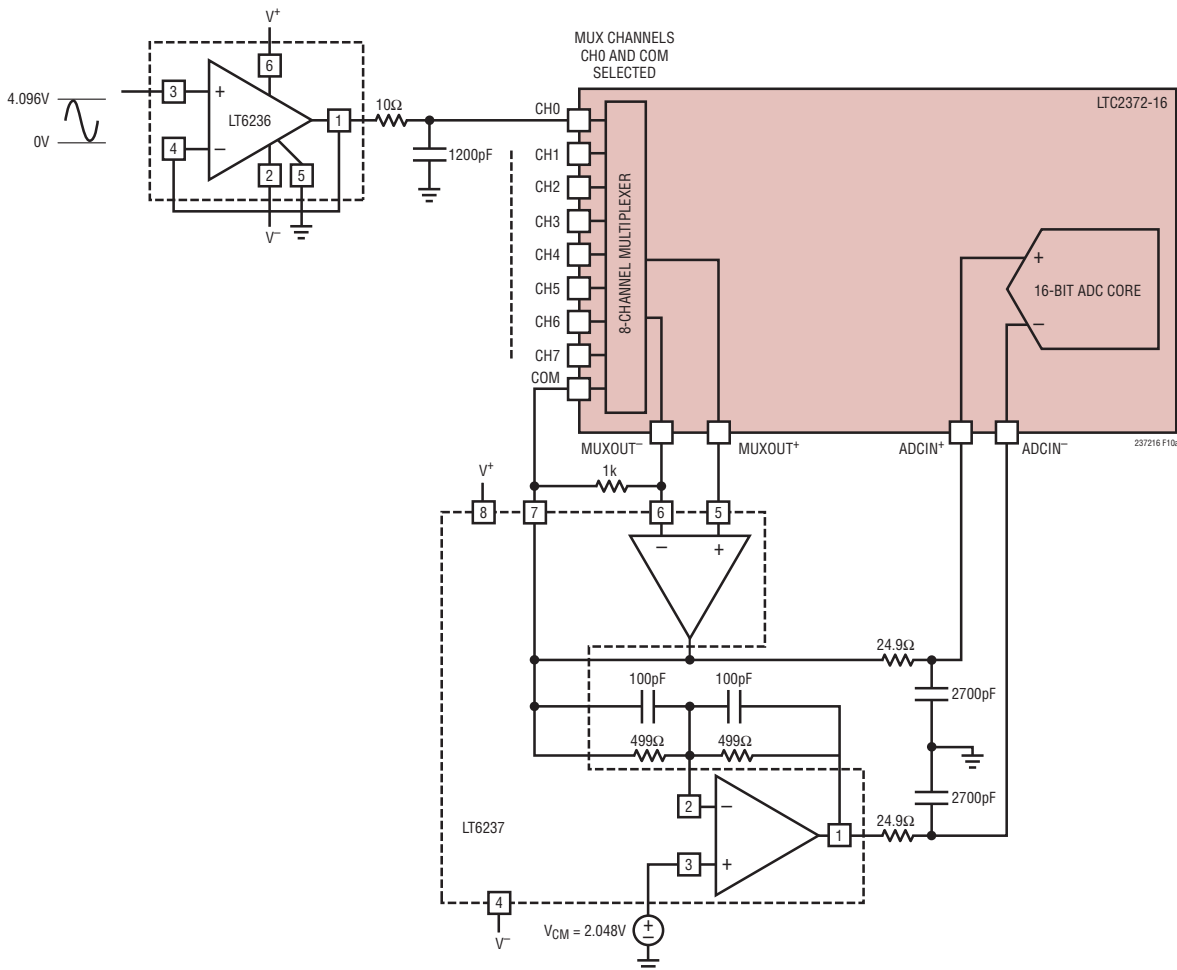


Figure 10a. LT6236 Buffering a Single-Ended 0V to 4.096V Input Signal and the LT6237 Configured to Perform a Single-Ended to Differential Conversion to the  $\pm 4.096V$  Fully Differential Input Range

237216f

## APPLICATIONS INFORMATION

### Using Digital Gain Compression for Single Supply Operation

The LTC2372-16 offers a digital gain compression (DGC) feature which defines the full-scale input swing to be between 10% and 90% of the  $\pm V_{\text{REFBUF}}$  analog input range. This feature allows the ADC driver to be powered off of a single positive supply since each input swings between 0.41V and 3.69V with  $V_{\text{REFBUF}} = 4.096\text{V}$  as in Figure 11a. Needing only a positive supply and ground to power the

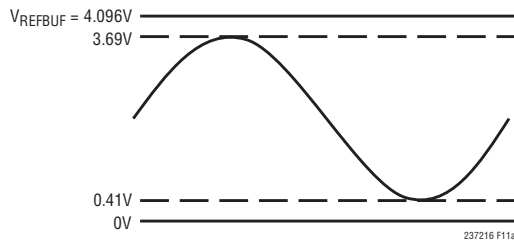


Figure 11a. Input Swing of the LTC2372-16 with Digital Gain Compression Enabled and  $V_{\text{REFBUF}} = 4.096\text{V}$

ADC driver results in additional power savings for the entire system versus conventional systems that have a negative supply for the ADC driver.

With DGC enabled, the LTC2372-16 can be driven by the low power LTC6362 differential driver which is powered from a single 5V supply. Figure 11b shows how to configure the LTC6362 to accept a  $\pm 3.28\text{V}$  true bipolar single-ended input signal and level shift the signal to the reduced input range of the LTC2372-16 when digital gain compression is enabled. Using the LT6236 to buffer the resistor divider that creates  $V_{\text{CM}}$ , the entire signal chain solution can be powered from a single 5V supply, minimizing power consumption and reducing complexity. The reduced input signal swing of this single 5V supply solution limits the achievable SNR to 94dB, as shown in the FFT of Figure 11c. To enable DGC, set SEL=1 in the configuration word.

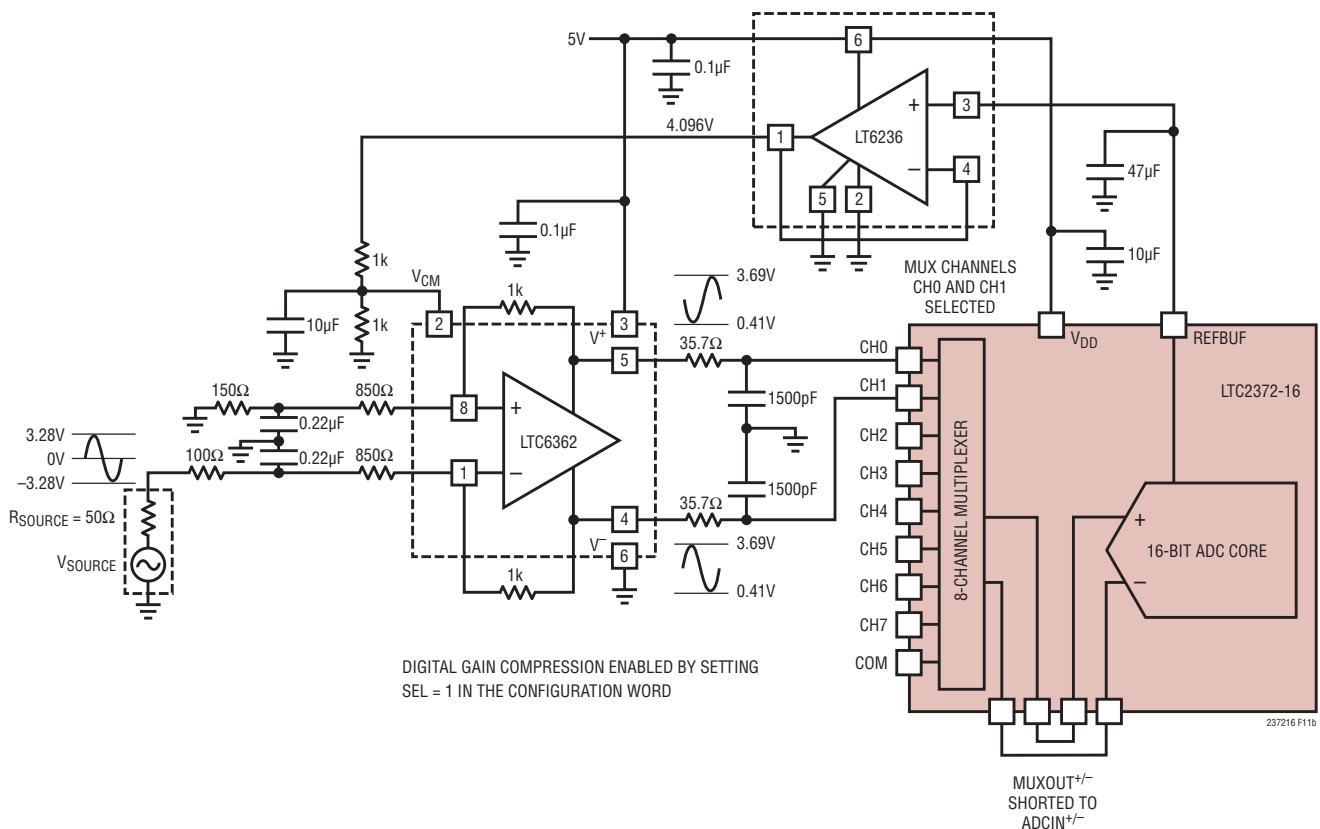


Figure 11b. LTC6362 Configured to Accept a  $\pm 3.28\text{V}$  Input Signal While Running from a Single 5V Supply When Digital Gain Compression is Enabled in the LTC2372-16

237216f

## APPLICATIONS INFORMATION

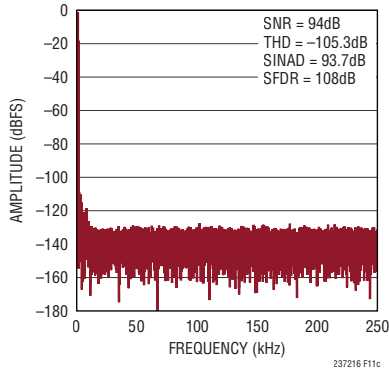


Figure 11c. 32k Point FFT  $f_{\text{SMPL}} = 500\text{kpsps}$ ,  $f_{\text{IN}} = 1\text{kHz}$  for Circuit Shown in Figure 11b

### ADC REFERENCE

There are three ways of providing the ADC reference. The first is to use both the internal reference and reference buffer. The second is to externally overdrive the internal reference and use the internal reference buffer. The third is to disable the internal reference buffer and overdrive the REFBUF pin from an external source. The following tables give examples of these cases and the resulting fully differential, unipolar and bipolar input ranges.

Table 2. Internal Reference with Internal Buffer

REFIN	REFBUF	FULLY DIFFERENTIAL INPUT RANGE	UNIPOLAR INPUT RANGE	BIPOLAR INPUT RANGE
2.048V	4.096V	$\pm 4.096\text{V}$	0V to 4.096V	$\pm 2.048\text{V}$

Table 3. External Reference with Internal Buffer

REFIN (OVERDRIVE)	REFBUF	FULLY DIFFERENTIAL INPUT RANGE	UNIPOLAR INPUT RANGE	BIPOLAR INPUT RANGE
1.25 (Min)	2.5V	$\pm 2.5\text{V}$	0V to 2.5V	$\pm 1.25\text{V}$
2.048V	4.096V	$\pm 4.096\text{V}$	0V to 4.096V	$\pm 2.048\text{V}$
2.4V (Max)	4.8V	$\pm 4.8\text{V}$	0V to 4.8V	$\pm 2.4\text{V}$

Table 4. External Reference Unbuffered

REFIN	REFBUF	FULLY DIFFERENTIAL INPUT RANGE	UNIPOLAR INPUT RANGE	BIPOLAR INPUT RANGE
0V	2.5V (Min)	$\pm 2.5\text{V}$	0V to 2.5V	$\pm 1.25\text{V}$
0V	5V (Max)	$\pm 5\text{V}$	0V to 5V	$\pm 2.5\text{V}$

### Internal Reference with Internal Buffer

The LTC2372-16 has an on-chip, low noise, low drift (20ppm/°C), temperature compensated bandgap reference that is factory trimmed to 2.048V. It is internally connected to a reference buffer as shown in Figure 12a and is available at REFIN (Pin 13). REFIN should be bypassed to GND with a 0.1  $\mu\text{F}$  ceramic capacitor to minimize noise. The reference buffer gains the REFIN voltage by 2 to 4.096V at REFBUF (Pin 12). Bypass REFBUF to GND with at least 47  $\mu\text{F}$  ceramic capacitor (X7R, 10V, 1210 size) to compensate the reference buffer and minimize noise.

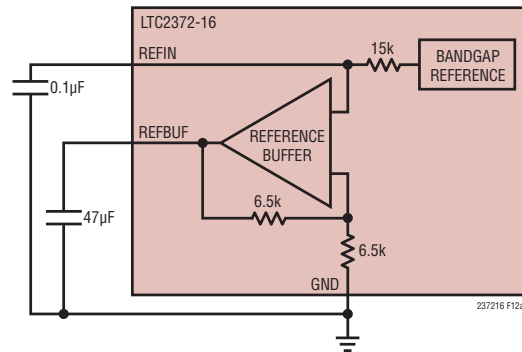


Figure 12a. LTC2372-16 Internal Reference Circuit

### External Reference with Internal Buffer

If more accuracy and/or lower drift is desired, REFIN can be easily overdriven by an external reference since a 15k resistor is in series with the reference as shown in Figure 12b. REFIN can be overdriven in the range from 1.25V to 2.4V. The resulting voltage at REFBUF will be  $2 \times \text{REFIN}$ . Linear Technology offers a portfolio of high performance references designed to meet the needs of

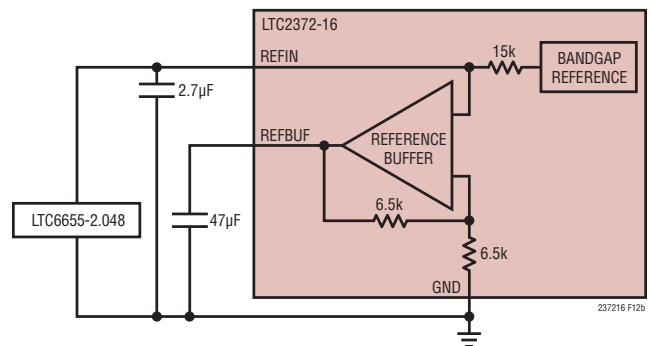


Figure 12b. Using the LTC6655-2.048 as an External Reference

## APPLICATIONS INFORMATION

many applications. With its small size, low power, and high accuracy, the LTC6655-2.048 is well suited for use with the LTC2372-16 when overdriving the internal reference. The LTC6655-2.048 offers 0.025% (max) initial accuracy and 2ppm/°C (max) temperature coefficient for high precision applications. The LTC6655-2.048 is fully specified over the H-grade temperature range and complements the extended temperature range of the LTC2372-16 up to 125°C. Bypassing the LTC6655-2.048 with a 2.7µF to 100µF ceramic capacitor close to the REFIN pin is recommended.

### External Reference Unbuffered

The internal reference buffer can also be overdriven from 2.5V to 5V with an external reference at REFBUF as shown in Figure 12c. To do so, REFIN must be grounded to disable the reference buffer. A 13k resistor loads the REFBUF pin when the reference buffer is disabled. To maximize the input signal swing and corresponding SNR, the LTC6655-5 is recommended when overdriving REFBUF. The LTC6655-5 offers the same small size, accuracy, drift and extended temperature range as the LTC6655-2.048. By using a 5V reference, an SNR of 97dB can be achieved. Bypassing the LTC6655-5 with a 47µF ceramic capacitor (X5R, 0805 size) close to the REFIN pin is recommended.

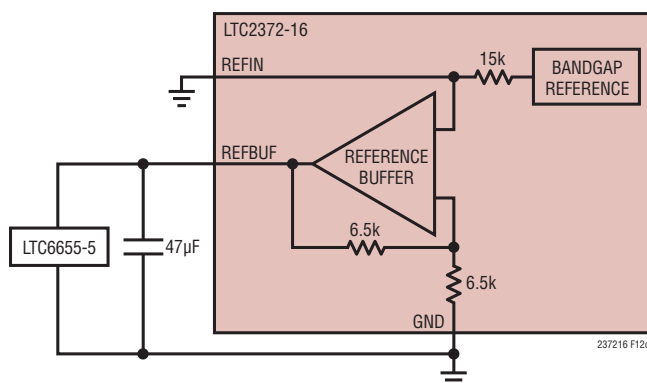


Figure 12c. Overdriving REFBUF Using the LTC6655-5

The REFBUF pin of the LTC2372-16 draws a charge ( $Q_{CONV}$ ) from the external bypass capacitor during each conversion cycle. If the internal reference buffer is overdriven, the

external reference must provide all of this charge with a DC current equivalent to  $I_{REFBUF} = Q_{CONV}/t_{CYC}$ . Thus, the DC current draw of REFBUF depends on the sampling rate and output code. In applications where a burst of samples is taken after idling for long periods, as shown in Figure 13,  $I_{REFBUF}$  quickly goes from approximately 380µA to a maximum of 1mA for REFBUF = 5V at 500ksps. This step in DC current draw triggers a transient response in the external reference that must be considered since any deviation in the voltage at REFBUF will affect the accuracy of the output code. If an external reference is used to overdrive REFBUF, the fast settling LTC6655-5 reference is recommended.

### Internal Reference Buffer Transient Response

For optimum transient performance, the internal reference buffer should be used. The internal reference buffer uses a proprietary design that results in an output voltage change at REFBUF of less than 1LSB when responding to a sudden burst of conversions. This makes the internal reference buffer of the LTC2372-16 truly single-shot capable since the first sample taken after idling will yield the same result as a sample taken after the transient response of the internal reference buffer has settled. Figures 14a, 14b, and 14c show the transient responses of the LTC2372-16 with the internal reference buffer and with the internal reference buffer overdriven by the LTC6655-5, both with a bypass capacitance of 47µF in fully differential, pseudo-differential unipolar, and pseudo-differential bipolar input ranges, respectively.

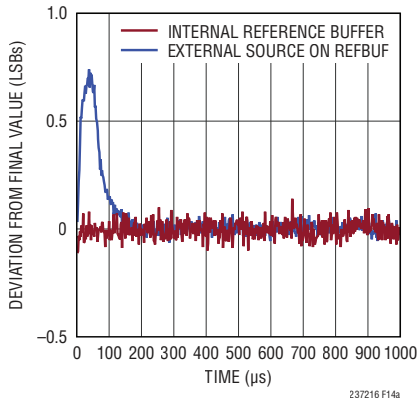
### DYNAMIC PERFORMANCE

Fast fourier transform (FFT) techniques are used to test the ADC's frequency response, distortion and noise at the rated throughput. By applying a low distortion sine wave and analyzing the digital output using an FFT algorithm, the ADC's spectral content can be examined for frequencies outside the fundamental. The LTC2372-16 provides guaranteed tested limits for both AC distortion and noise measurements.

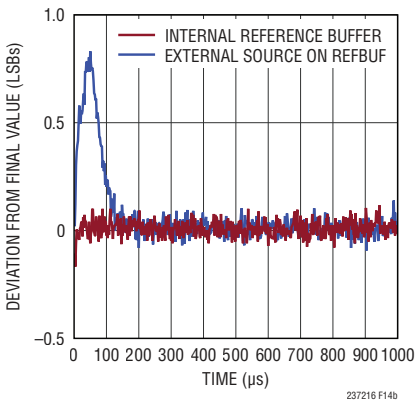


Figure 13. CNV Waveform Showing Burst Sampling

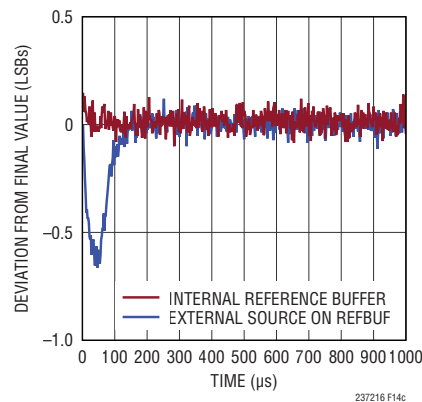
## APPLICATIONS INFORMATION



**Figure 14a. Transient Response of the LTC2372-16 in the Fully Differential Input Range**



**Figure 14b. Transient Response of the LTC2372-16 in the Pseudo-Differential Unipolar Input Range**

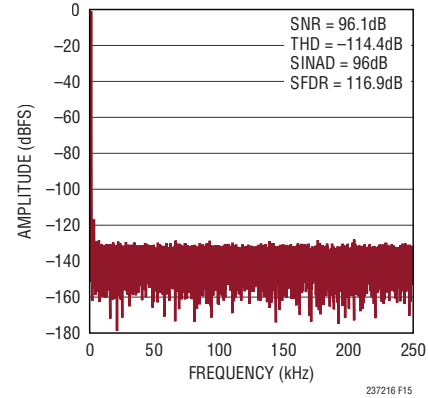


**Figure 14c. Transient Response of the LTC2372-16 in the Pseudo-Differential Bipolar Input Range**

### Signal-to-Noise and Distortion Ratio (SINAD)

The signal-to-noise and distortion ratio (SINAD) is the ratio between the RMS amplitude of the fundamental input

frequency and the RMS amplitude of all other frequency components at the A/D output. The output is band limited to frequencies from above DC and below half the sampling frequency. Figure 15 shows that the LTC2372-16 achieves a typical SINAD of 96dB (fully differential) at a 500kHz sampling rate with a 1kHz input.



**Figure 15. 32k Point FFT  $f_{SMP\_L} = 500kps$ ,  $f_{IN} = 1kHz$**

### Signal-to-Noise Ratio (SNR)

The signal-to-noise ratio (SNR) is the ratio between the RMS amplitude of the fundamental input frequency and the RMS amplitude of all other frequency components except the first five harmonics and DC. Figure 15 shows that the LTC2372-16 achieves a typical SNR of 96dB (fully differential) at a 500kHz sampling rate with a 1kHz input.

### Total Harmonic Distortion (THD)

Total harmonic distortion (THD) is the ratio of the RMS sum of all harmonics of the input signal to the fundamental itself. The out-of-band harmonics alias into the frequency band between DC and half the sampling frequency ( $f_{SMP\_L}/2$ ). THD is expressed as:

$$THD = 20 \log \frac{\sqrt{V_2^2 + V_3^2 + V_4^2 + \dots + V_N^2}}{V_1}$$

where  $V_1$  is the RMS amplitude of the fundamental frequency and  $V_2$  through  $V_N$  are the amplitudes of the second through Nth harmonics. Figure 15 shows that the LTC2372-16 achieves a typical THD of -114dB (fully differential) at a 500kHz sampling rate with a 1kHz input.

## APPLICATIONS INFORMATION

### POWER CONSIDERATIONS

The LTC2372-16 provides two power supply pins: the 5V power supply ( $V_{DD}$ ), and the digital input/output interface power supply ( $OV_{DD}$ ). The flexible  $OV_{DD}$  supply allows the LTC2372-16 to communicate with any digital logic operating between 1.8V and 5V, including 2.5V and 3.3V systems.

### Power Supply Sequencing

The LTC2372-16 does not have any specific power supply sequencing requirements. Care should be taken to adhere to the maximum voltage relationships described in the Absolute Maximum Ratings section. The LTC2372-16 has a power-on-reset (POR) circuit that will reset the LTC2372-16 at initial power-up or whenever the power supply voltage drops below 2V. Once the supply voltage re-enters the nominal supply voltage range, the POR will reinitialize the ADC. No conversions should be initiated until 100ms after a POR event to ensure the reinitialization period has ended. Any conversions initiated before this time will produce invalid results.

## TIMING AND CONTROL

### CNV Timing

The LTC2372-16 conversion is controlled by CNV. A rising edge on CNV will start a conversion and power up the LTC2372-16. Once a conversion has been initiated, it cannot be restarted until the conversion is complete. For optimum performance, CNV should be driven by a clean low jitter signal. Converter status is indicated by the BUSY output which remains high while the conversion is in progress. To ensure that no errors occur in the digitized results, any additional transitions on CNV should occur within 40ns from the start of the conversion or after the conversion has been completed. Once the conversion has completed, the LTC2372-16 powers down. It is not necessary to clock out all of the data and configuration bits before starting a new conversion.

### Acquisition

A proprietary sampling architecture allows the LTC2372-16 to begin acquiring the input signal for the next conversion 527ns after the start of the current conversion. This

extends the acquisition time to 1.460 $\mu$ s, easing settling requirements and allowing the use of extremely low power ADC drivers. (Refer to Timing Diagrams)

### Internal Conversion Clock

The LTC2372-16 has an internal clock that is trimmed to achieve a maximum conversion time of 1.5 $\mu$ s.

### Auto Nap Mode

The LTC2372-16 automatically enters nap mode after a conversion has been completed and completely powers up once a new conversion is initiated on the rising edge of CNV. During nap mode, only the ADC core powers down and all other circuits remain active. During nap, data from the last conversion can be clocked out. The auto nap mode feature will reduce the power dissipation of the LTC2372-16 as the sampling frequency is reduced. Since full power is consumed only during a conversion, the ADC core of the LTC2372-16 remains powered down for a larger fraction of the conversion cycle ( $t_{CYC}$ ) at lower sample rates, thereby reducing the average power dissipation which scales with the sampling rate as shown in Figure 16.

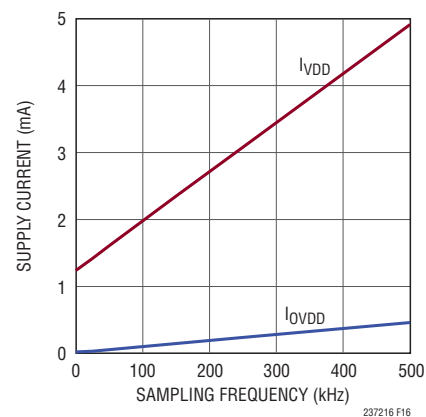


Figure 16. Power Supply Current of the LTC2372-16 vs Sampling Rate

### Sleep Mode

The auto nap mode feature provides limited power savings since only the ADC core powers down. To obtain greater power savings, the LTC2372-16 provides a sleep mode. During sleep mode, the entire part is powered down except for a small standby current resulting in a power dissipation of 300 $\mu$ W. To enter sleep mode, toggle CNV

237216f

## APPLICATIONS INFORMATION

twice with no intervening rising edge on SCK. The part will enter sleep mode on the falling edge of BUSY from the last conversion initiated. Once in sleep mode, a rising edge on SCK will wake the part up. Upon emerging from sleep mode, wait  $t_{WAKE}$  ms before initiating a conversion to allow the reference and reference buffer to wake-up and charge the bypass capacitors at REFIN and REFBUF. (Refer to the Timing Diagrams section for more detailed timing information about sleep mode.)

### DIGITAL INTERFACE

The LTC2372-16 has a serial digital interface. The flexible  $OV_{DD}$  supply allows the LTC2372-16 to communicate with any digital logic operating between 1.8V and 5V, including 2.5V and 3.3V systems.

The serial data I/O bus is enabled when RDL is low. Serial output data is clocked out on the SDO pin and serial input configuration data is clocked in at the SDI pin when an external clock is applied to the SCK pin if the serial data I/O bus is enabled. Serial output data transitions on rising edges of SCK and serial input data is latched on rising edges of SCK. D15 remains valid till the first rising edge of SCK. After the 16 bits of the conversion result are shifted out, a start-of-sequence (SOS) bit followed by the 7-bit control word corresponding to the conversion result is shifted out. SDO will remain low after 24 SCK rising edges have been issued. Clocking out the data and configuration information after the conversion will yield the best performance. Table 5 lists the minimum shift clock frequency needed to achieve 500ksps throughput when shifting out a different number of bits.

**Table 5. Minimum Shift Clock Frequency vs Number of Bits for 500ksps**

	NUMBER OF BITS	$f_{SCK}$ (MHz)
Conversion Result	16	35
Conversion Result + SOS Bit	17	37
Conversion Result + SOS Bit + Configuration Data	24	52

The configuration of the LTC2372-16 is programmed via a sequencer through the serial interface. The following sections describe the various ways the LTC2372-16 can be programmed, the operation of the sequencer and general use of the LTC2372-16.

### Configuring the LTC2372-16

The various modes of operation of the LTC2372-16 are programmed by seven bits of an 8-bit control word, C[7:0]. The control word is shifted in at SDI on the rising edges of SCK, MSB first. The control word is defined as follows:

C[7]	C[6]	C[5]	C[4]	C[3]	C[2]	C[1]	C[0]
X	A[3]	A[2]	A[1]	A[0]	R[1]	R[0]	SEL

The MSB of the control word, C[7], is used during the programming of the sequencer and does not control the operating mode or configuration of the MUX or ADC (see Programming the Sequencer section). Referring to Table 6, bits A[3:0] (C[6:3]) control the analog input MUX channel configuration. Bits R[1:0] (C[2:1]) control the input range configuration of the ADC and the SEL (C[0]) bit enables/disables the digital gain compression feature (see Using Digital Gain Compression for Single Supply Operation section).

**Table 6. Description of Decoded Configuration Bits**

BITS	NAME	BEHAVIOR
[A3:A0]	MUX Channel Configuration Bits	See Table 7
[R1:R0]	Input Range Selection Bits	<b>00</b> – Pseudo-Differential Unipolar Input (Straight Binary Output Data Format) <b>01</b> – Pseudo-Differential Bipolar Input (Two's-Complement Output Data Format) <b>10</b> – Fully Differential Input (Straight Binary Output Data Format) <b>11</b> – Fully Differential Input (Two's-Complement Output Data Format)
SEL	Digital Gain Compression Bit	<b>0</b> – Digital Gain Compression Disabled <b>1</b> – Digital Gain Compression Enabled

Note: Digital gain compression feature always disabled for the pseudo-differential unipolar input range.

### Analog Input Multiplexer

The analog input MUX is programmed by the A[3:0] (C[6:3]) bits of the input control word. Table 7 lists the MUX configurations for all combinations of the configuration bits. The selected positive (+) channel is output to MUXOUT<sup>+</sup> and the selected negative (–) channel is output to MUXOUT<sup>–</sup>. Figure 17 shows an example of the MUX configuration being updated on successive conversions. Note how the voltages of the selected positive (+)

## APPLICATIONS INFORMATION

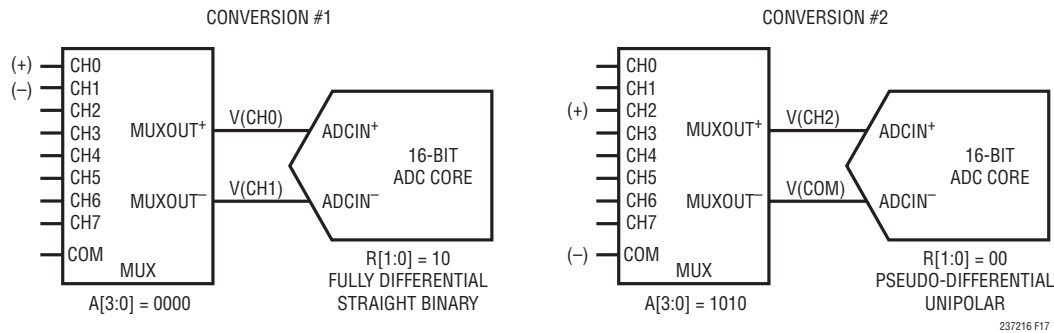


Figure 17. Changing the Configuration of the LTC2372-16 on Successive Conversions

and negative (-) channels are output at MUXOUT<sup>+</sup> and MUXOUT<sup>-</sup>, respectively.

Table 7. Channel Configuration

MUX CONFIGURATION BITS				MULTIPLEXER CONFIGURATION								
A[3]	A[2]	A[1]	A[0]	CH0	CH1	CH2	CH3	CH4	CH5	CH6	CH7	COM
0	0	0	0	+	-							
0	0	0	1			+	-					
0	0	1	0					+	-			
0	0	1	1							+	-	
0	1	0	0	-	+							
0	1	0	1			-	+					
0	1	1	0					-	+			
0	1	1	1							-	+	
1	0	0	0	+								-
1	0	0	1		+							-
1	0	1	0			+						-
1	0	1	1				+					-
1	1	0	0					+				-
1	1	0	1						+			-
1	1	1	0							+		-
1	1	1	1								+	-

## Sequencer

The LTC2372-16 features a sequencer that can store up to 16 7-bit control words in internal memory. The 7-bit control word is defined in the Configuring the LTC2372-16 section. The sequencer repeatedly cycles through the control words stored in sequencer memory on successive conversions if no new valid control words are input to the part in a given transaction. The sequencer memory is shown in Figure 18a.

An internal memory pointer determines which of the up to 16 programmed control words is currently controlling the converter. The pointer is reset to point to the first programmed control word each time the sequencer memory is programmed. Upon reaching the final programmed control word stored in memory, the pointer is automatically reset to the first memory location and the sequence is restarted. At power-up or after resetting the LTC2372-16, the internal sequencer memory programming defaults to a depth of 1 with control word C0[6:0] = 0000000 (CH0<sup>+</sup>/CH1<sup>-</sup>, unipolar input range, digital gain compression disabled). Figure 18b shows the sequencer memory programmed with 8 configurations along with the memory pointer location for conversions run after programming.

## Start of Sequence

The start of sequence (SOS) bit is output to SDO on the 17th SCK cycle during all SPI transactions and indicates whether the configuration for the conversion just performed corresponds to the control word stored in the first memory location of the sequencer memory. When SOS=1, the current configuration corresponds to the first memory location of the sequencer. The SOS bit can be used to align the conversion data with the corresponding control word when truncated SPI transactions are used to maximize throughput. Only one extra bit needs to be shifted out to maintain alignment of the configuration with the conversion data. This results in needing 17 SCK cycles instead of 24, which allows a higher throughput to be achieved while being able to keep the configuration information properly aligned with the conversion data.

## APPLICATIONS INFORMATION

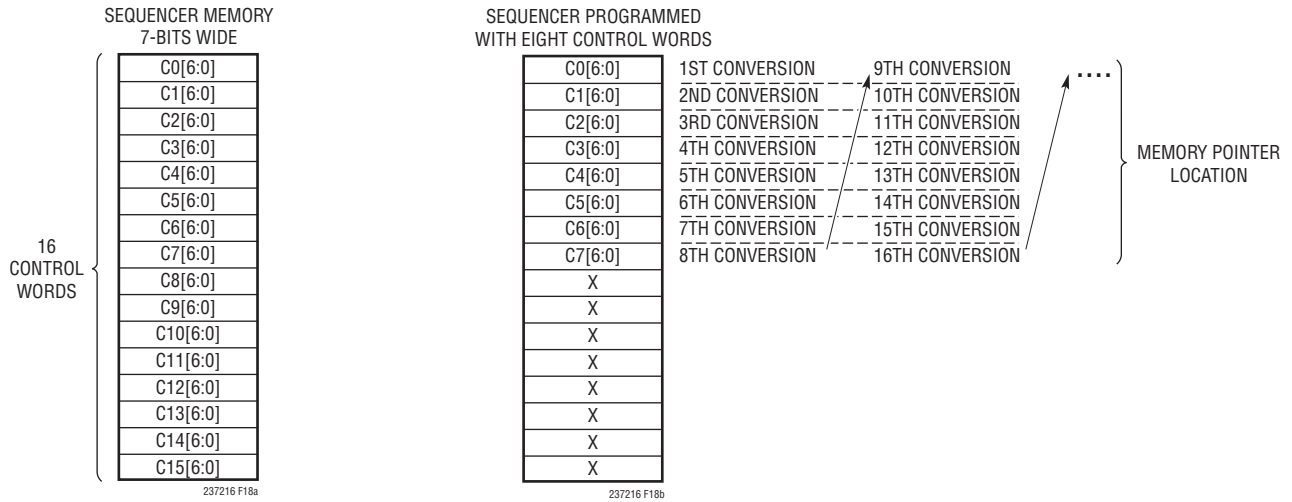


Figure 18a. Internal Sequencer Memory

Figure 18b. Sequencer Programmed with Eight Control Words and the Memory Pointer Location for Conversions Run After Programming

### Programming the Sequencer Transaction Window

A transaction window opens at power-up, after resetting the LTC2372-16, and every conversion cycle at the falling edge of BUSY, allowing the sequencer to be programmed. Once the transaction window opens, the state machine controlling the programming of the sequencer memory is in a reset state, waiting for control words to be shifted in at SDI. The transaction window closes at the start of the next conversion when BUSY transitions from low to high, as shown in Figure 19. Serial input data at SDI is ignored by the sequencer state machine when BUSY is high.

### Input Control Word

The input control word is used to determine whether or not the sequencer is being programmed. In many cases the user will simply need to configure the converter once

for their specific application after power-up or resetting the part, and then drive the SDI pin to GND. This will force the control word bits to all zeros and the converter will automatically sequence through the configurations stored in sequencer memory. The following sections provide further details on programming the sequencer.

The sequencer memory may be programmed by inputting one or more valid control words at SDI. Each control word is an 8-bit word as described in the Configuring the LTC2372-16 section. A valid input control word is one where C[7] = 1 and the remaining lower 7-bits, C[6:0], have been shifted in before the transaction window closes as shown in Figure 20a. When the 1st control word is successfully entered on the 8th rising edge of SCK, the sequencer memory is cleared, the new configuration, C[6:0], is written into the first memory location and is applied to the converter. At this point, a new acquisition window begins since the

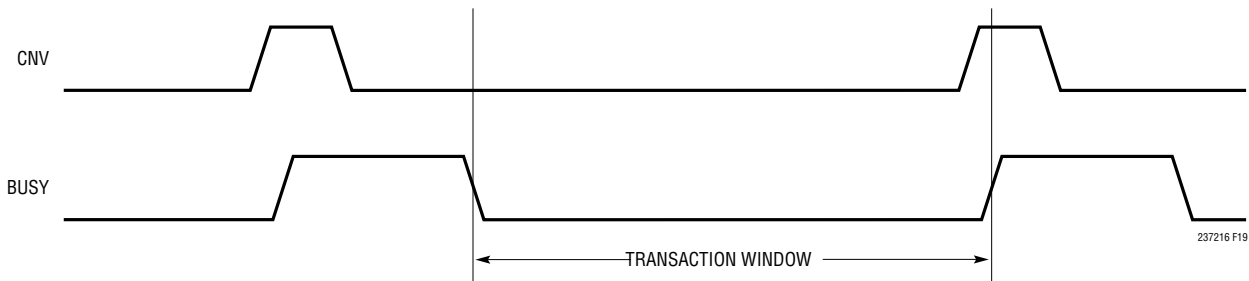
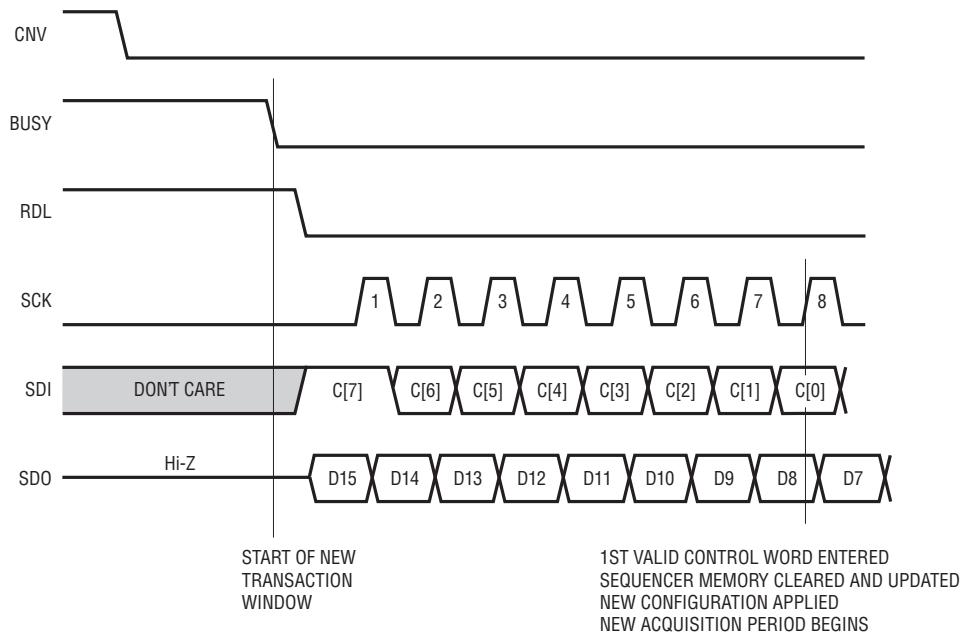


Figure 19. Sequencer Programming Transaction Window

## APPLICATIONS INFORMATION

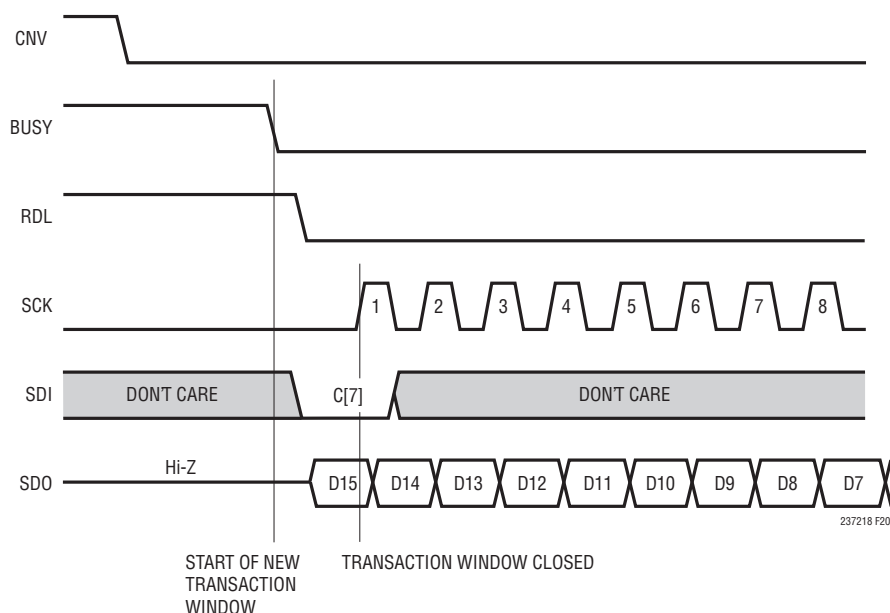
new configuration may result in a different channel being acquired. Additional valid input control words are written into subsequent memory locations. The sequencer only stores valid input control words and discards control words that are partially written or have  $C[7] = 0$ . If  $C[7] = 0$  at any point during sequencer programming, the LTC2372-16 closes the input transaction window until the completion

of the next conversion as shown in Figure 20b. Figure 21 shows a truncated programming transaction where the first partial input control word is discarded and the second complete input control word is successfully programmed. The transaction window also closes after 16 successive valid input control words have been written, since the sequencer memory has been filled.



237218 F20a

**Figure 20a. Valid Control Word Successfully Programmed,  $C[7] = 1$**



237218 F20b

**Figure 20b. Invalid Control Word Entered,  $C[7] = 0$**

237216f

APPLICATIONS INFORMATION

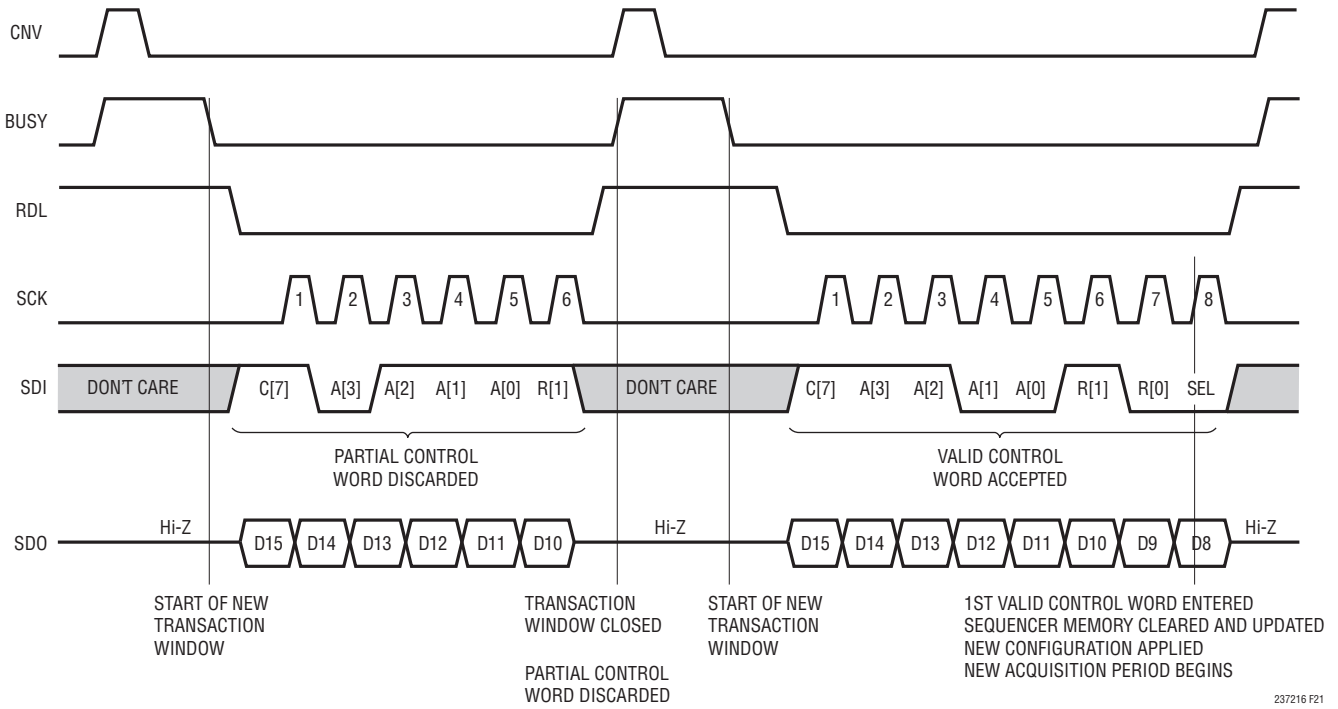


Figure 21. Truncated Programming Transaction Followed by the Successful Programming of One Configuration

237216 F21

## APPLICATIONS INFORMATION

### Programming the Sequencer with Two Configurations

Figure 22 illustrates the sequencer memory being programmed while reading out a conversion result. C[7] of the first two input control words is 1, so these control words are valid and are written to sequencer memory in succession. C[7] of the third control word is 0, so the input transaction is terminated at this point. Since there were only two valid control words entered, the sequencer memory is programmed with a depth of two. Figure 23 shows the state of the sequencer memory before, during, and after the programming process. The first stored configuration will instruct the converter to sample a fully differential signal on the CH7+/CH6- pair with digital gain compression disabled, and the second stored configuration will instruct the converter to sample a unipolar signal on the CH3/COM pair with digital gain compression disabled. The converter will then alternate between the two programmed configurations on successive conversions. Note that configurations stored in sequencer memory are retained until the power is cycled, the part is reset, or a new series of configuration programming words are input.

ing and after the programming process. The first stored configuration will instruct the converter to sample a fully differential signal on the CH7+/CH6- pair with digital gain compression disabled, and the second stored configuration will instruct the converter to sample a unipolar signal on the CH3/COM pair with digital gain compression disabled. The converter will then alternate between the two programmed configurations on successive conversions. Note that configurations stored in sequencer memory are retained until the power is cycled, the part is reset, or a new series of configuration programming words are input.

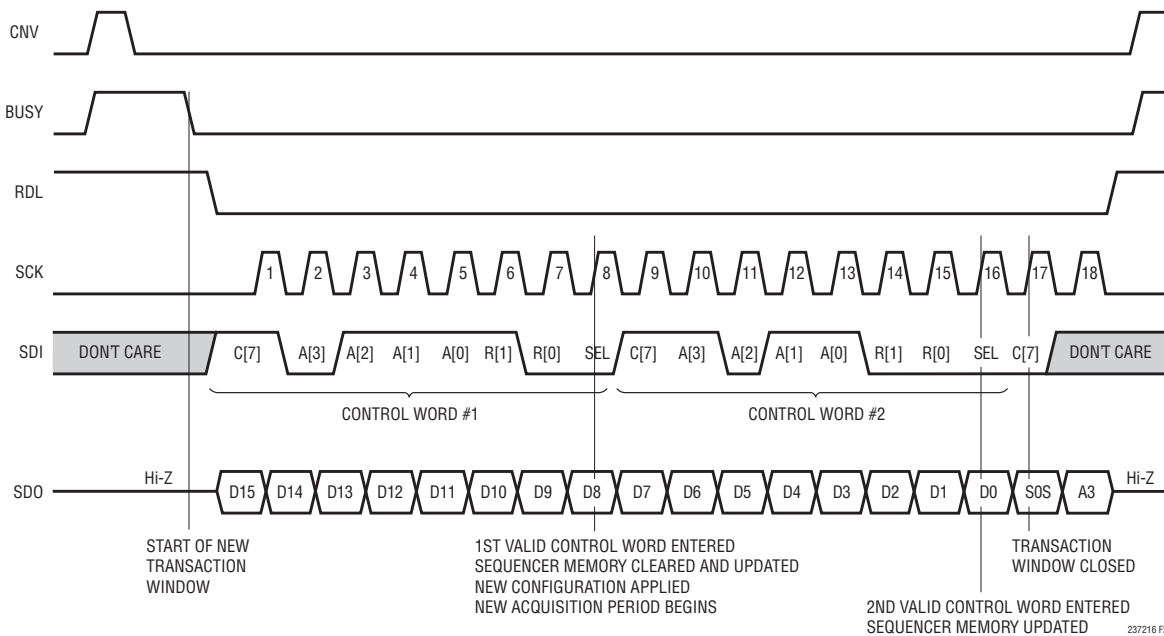


Figure 22. Sequencer Programmed with Two Control Words

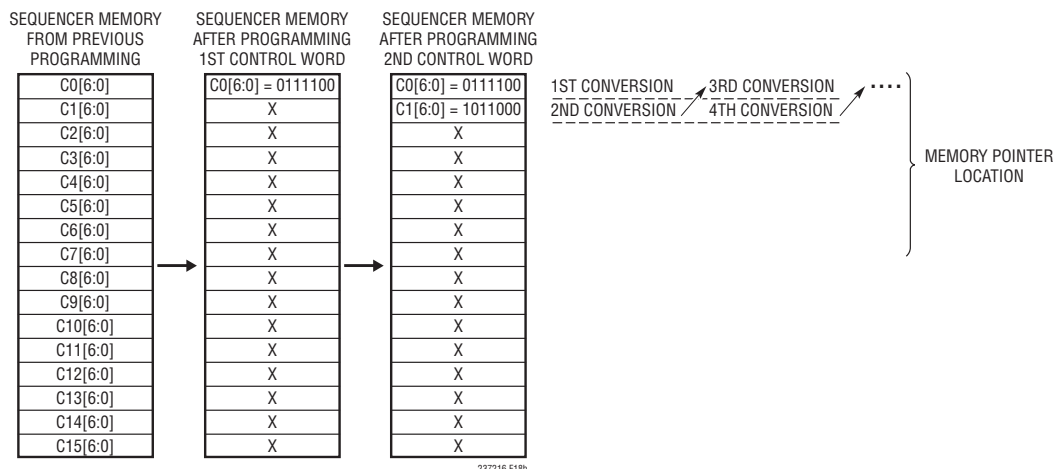


Figure 23. Sequencer Memory Before, During and After Programming

## TIMING DIAGRAMS

### MUX Reset Timing

The parasitic capacitances ( $C_{PAR}$ ) on the output summing nodes of the MUX,  $MUXOUT^{+/-}$ , are discharged to ground every conversion cycle and when a first new valid configuration word is programmed into the sequencer. This is done to avoid crosstalk between input channels due to charge sharing from  $C_{PAR}$ . The bottom most waveform in Figure 24 represents the voltages of the MUX output nodes. The MUX is being reset when  $V(MUXOUT^{+/-})$  sits at 0V.

The MUX turns OFF and begins resetting  $t_{CNVMRST}$  ns after a conversion is initiated by the rising edge of CNV. After  $t_{MRST1}$  ns, the MUX turns ON to the next channel programmed in the sequencer.

The MUX also turns OFF and resets after  $t_{VLDMRST}$  ns when a first new valid configuration word is programmed into the sequencer on the 8th rising edge of SCK. This is because the MUX may need to switch channels based on the newly input configuration, so memory of the previous channel needs to be cleared. A new acquisition period begins when the MUX is reconnected after  $t_{MRST2}$  ns.

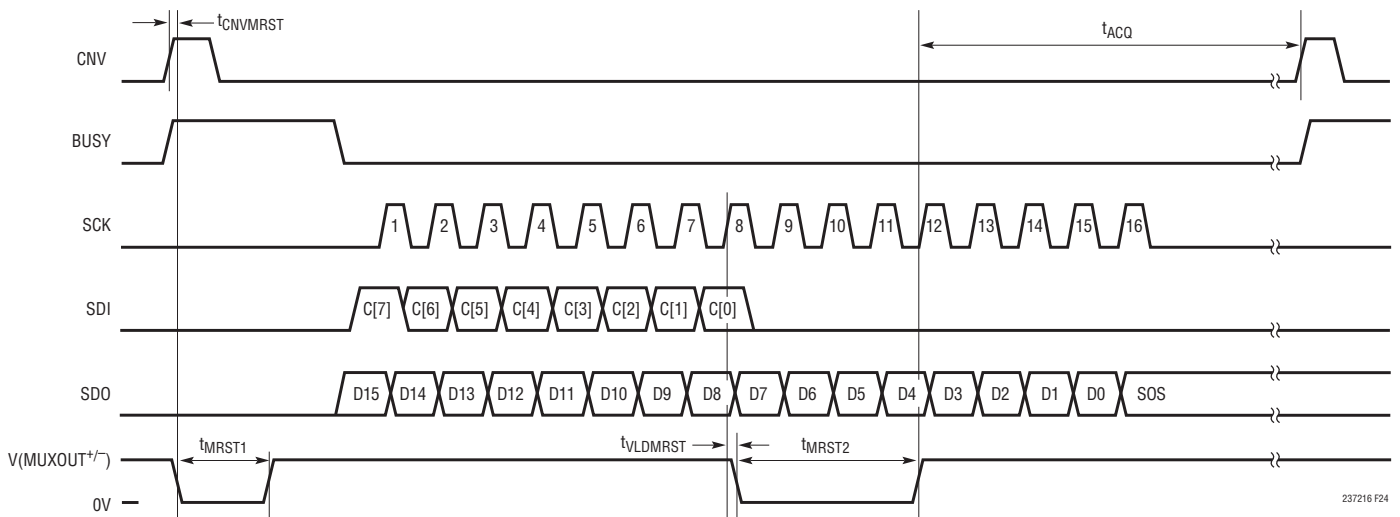


Figure 24. MUX Reset Timing

## TIMING DIAGRAMS

### Single Device, Sequencer Not Programmed

RDL enables or disables the serial data I/O bus. If RDL is high, the serial data I/O bus is disabled and the serial shift clock SCK is ignored. If RDL is low, SDO is driven and serial input data may be shifted in at SDI. Figure 25 shows a single LTC2372-16 operated with RDL and RESET tied to ground. With RDL grounded, the serial data I/O bus is enabled and the MSB(D15) of the new conversion data

is available  $t_{DSDO\text{BUSYL}}$  after the falling edge of BUSY. The start-of-sequence (SOS) bit followed by the current configuration is shifted out after the conversion data.

Bringing SDI low during data readback as shown closes the sequencer programming window at the first rising edge of SCK after the falling edge of BUSY since  $C[7] = 0$ . As a result, the sequencer is not programmed.

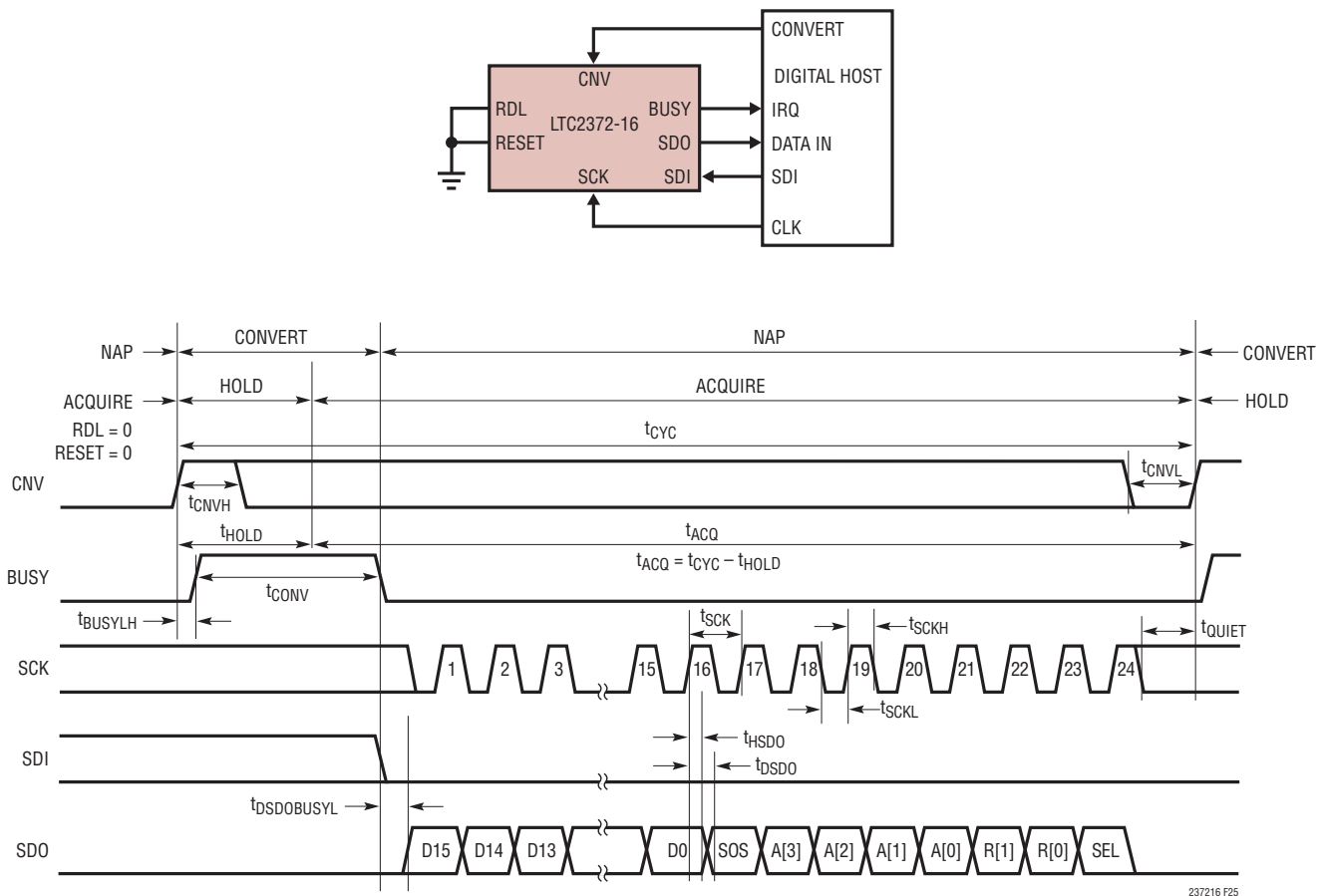


Figure 25. Using a Single LTC2372-16 without Programming the Sequencer

## TIMING DIAGRAMS

### Single Device, Sequencer Programmed

Figure 26 shows the timing for a single device being operated with RDL and RESET tied to ground. With RDL grounded, the serial data I/O bus is enabled and the MSB(D15) of the new conversion data is available  $t_{DSDO\text{BUSYL}}$  after the falling edge of BUSY. The start-of-sequence (SOS) bit followed by the configuration used for the conversion just performed is shifted out after the new conversion data.

When SDI is high at the first rising edge of SCK after the falling edge of BUSY as shown, the sequencer programming window stays open, allowing the sequencer to be programmed. With the sequencer programming window

open, a valid input configuration is detected on the 8th rising edge of SCK. At this point, the MUX turns OFF and resets and sequencer memory is reset and updated with the new configuration. The new channel configuration is applied when the MUX turns ON, marking the beginning of a new acquisition period.

### 'On the Fly' Device Programming

The sequencer may be programmed with one control word as shown in Figure 26 every conversion cycle to achieve complete flexibility in the multiplexer configuration, input range and digital gain compression setting on each conversion.

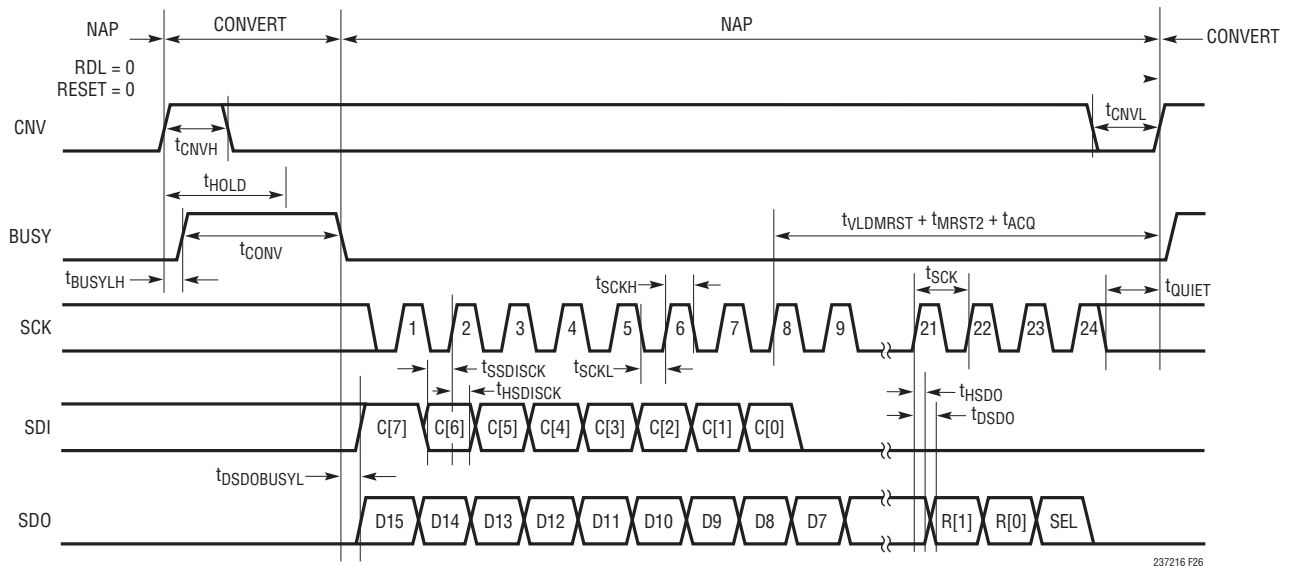


Figure 26. Using a Single LTC2372-16 Programming the Sequencer

# TIMING DIAGRAMS

## Multiple Devices

Figure 27 shows the multiple LTC2372-16 devices operating and sharing CNV, SDI, SCK and SDO. By sharing CNV, SDI, SCK and SDO, the number of signals required to operate multiple ADCs in parallel is reduced. Since SDO is shared, the RDL input of each ADC must be used to allow only one LTC2372-16 to drive SDO at a time in order to

avoid bus conflicts. RDL must also be used to selectively program each ADC through the shared SDI input line. The RDL inputs idle high and are individually brought low to read data out of and selectively program each device between conversions. When RDL is brought low, the MSB(D15) of the selected device is output onto SDO.

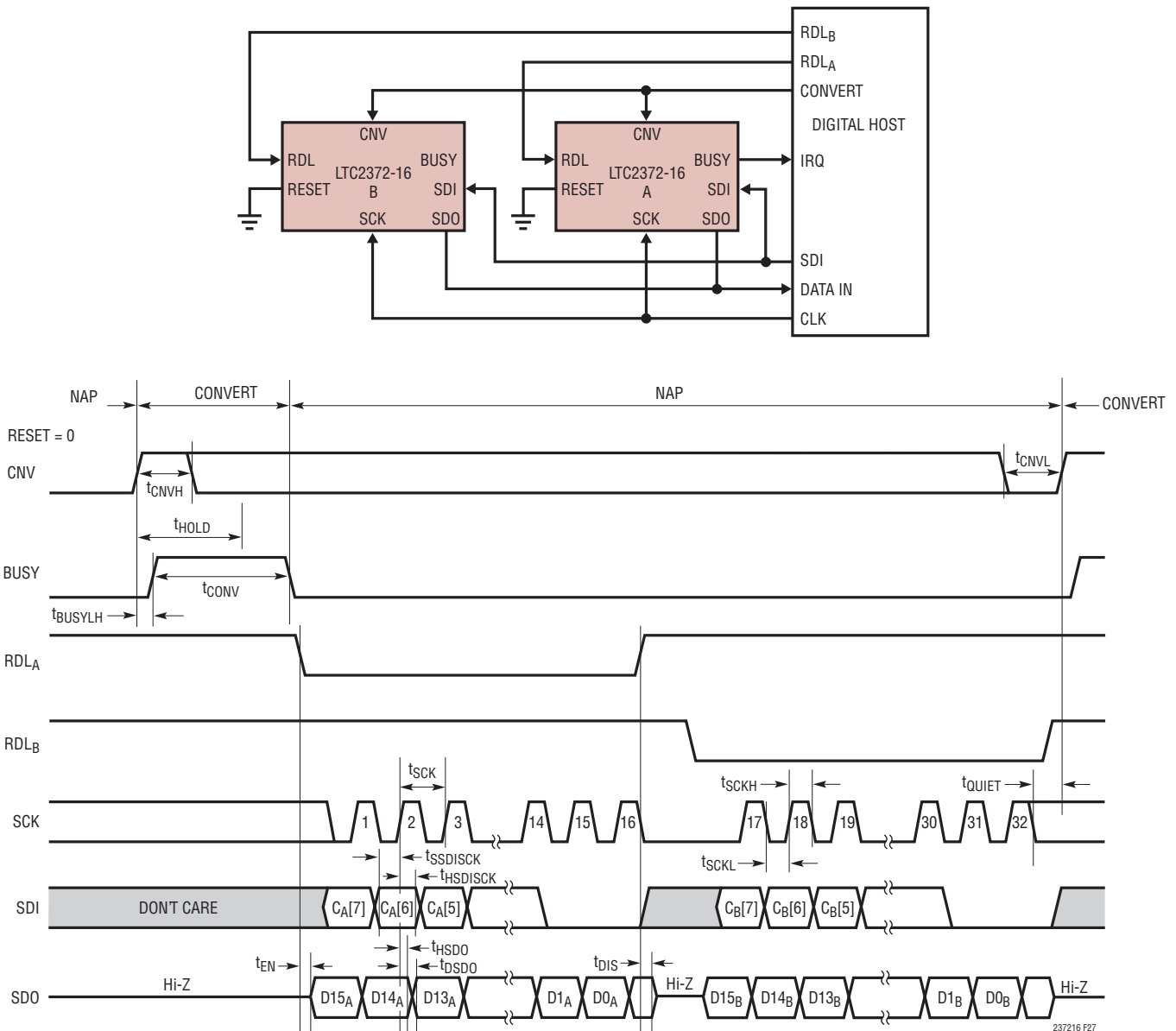


Figure 27. Multiple Devices Sharing CNV, SCK and SDO

## TIMING DIAGRAMS

### Sleep Mode

The LTC2372-16 automatically naps once a conversion has completed. Only the ADC core powers down in nap mode. As a result, the auto nap feature provides limited power savings. To obtain greater power savings, the LTC2372-16 provides a sleep mode. During sleep mode, the entire part is powered down except for a small standby current resulting in a 300µW power dissipation. To enter sleep mode, toggle CNV twice with no intervening rising edge on SCK as shown in Figure 28. The part will enter sleep mode on

the falling edge of BUSY from the last conversion initiated. Once in sleep mode, a rising edge on SCK will wake the part up. Upon emerging from sleep mode, wait  $t_{WAKE}$  ms before initiating a conversion to allow the reference and reference buffer to wake-up and charge the bypass capacitors at REFIN and REFBUF. The serial data I/O bus is enabled or disabled by RDL during sleep mode. Sleep mode does not affect the state of the sequencer memory or memory pointer.

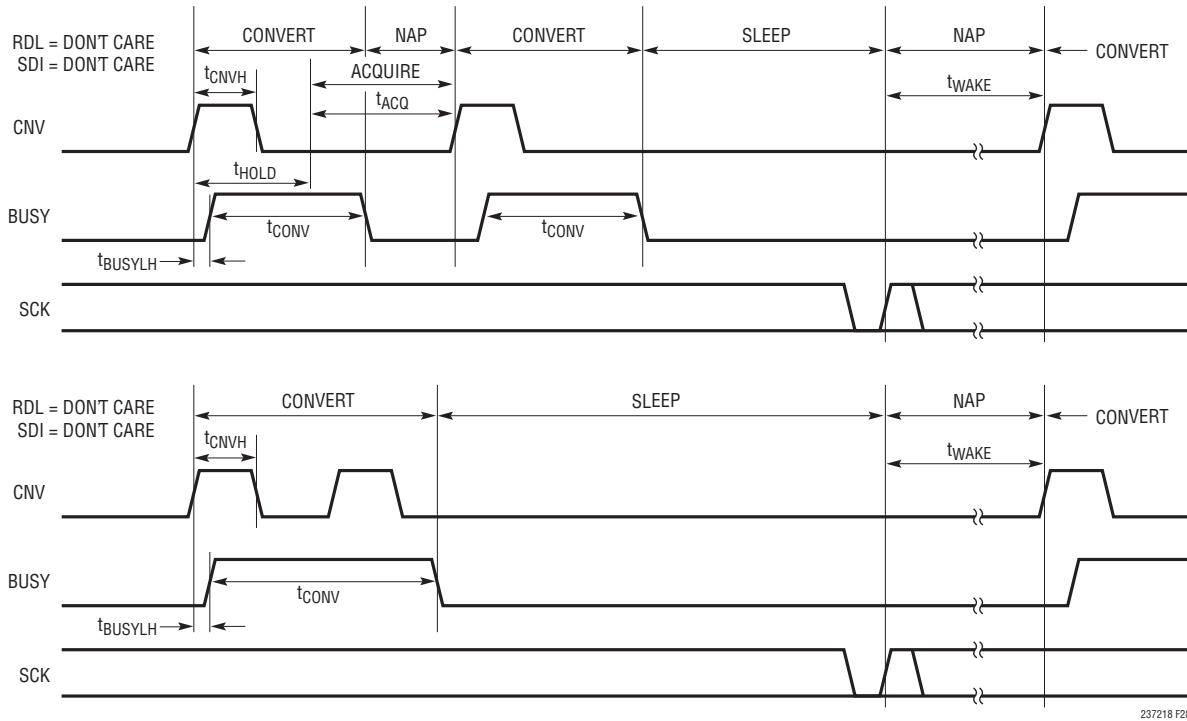


Figure 28. Sleep Mode Timing Diagram

## TIMING DIAGRAMS

### RESET Timing

When the RESET pin is high, the LTC2372-16 is reset and the serial I/O data bus is put into a high impedance mode, as shown in Figure 29. The serial data output register and sequencer memory are also cleared and set to their default

states. If this occurs during a conversion, the conversion is immediately halted. During reset, requests for new conversions are ignored. Once RESET returns low, the LTC2372-16 is ready to start a new conversion after the acquisition time has been met.

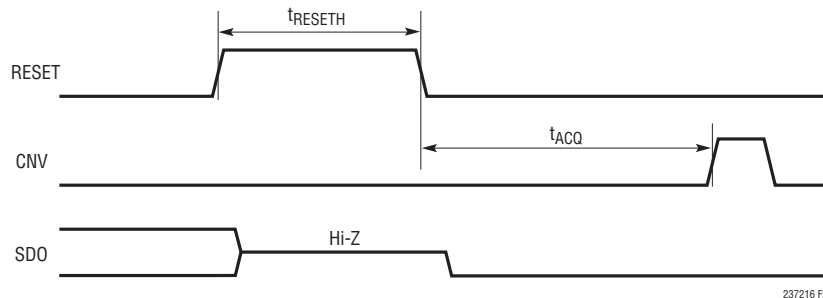


Figure 29. RESET Pin Timing

## BOARD LAYOUT

To obtain the best performance from the LTC2372-16 a printed circuit board is recommended. Layout for the printed circuit board (PCB) should ensure the digital and analog signal lines are separated as much as possible. In particular, care should be taken not to run any digital clocks or signals alongside analog signals or underneath the ADC.

### Recommended Layout

The following is an example of a recommended PCB layout. A single solid ground plane is used. Bypass capacitors to the supplies are placed as close as possible to the supply pins. Low impedance common returns for these bypass capacitors are essential to the low noise operation of the ADC. The analog input traces are screened by ground. For more details and information refer to DC2071, the evaluation kit for the LTC2372-16.

BOARD LAYOUT

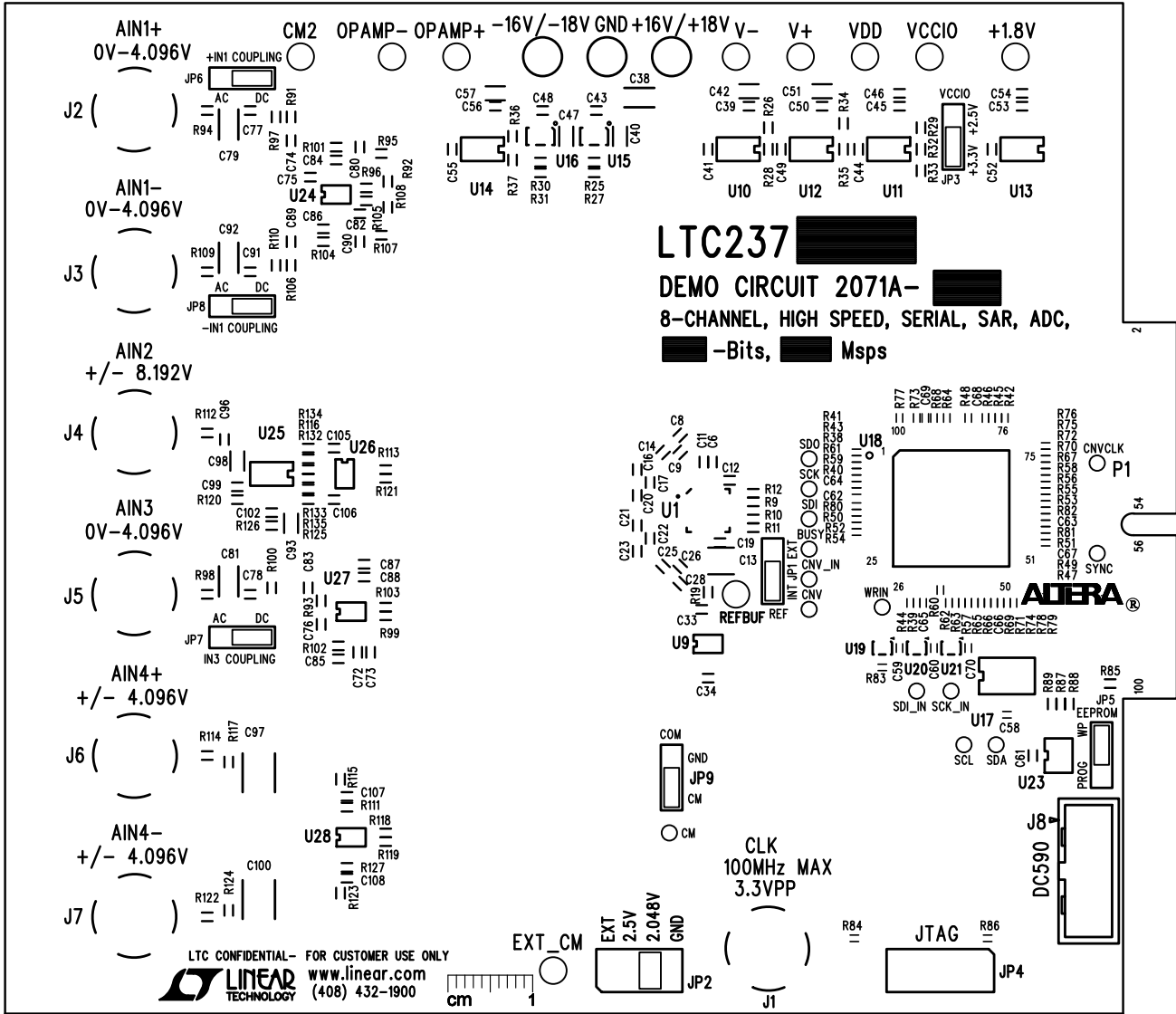


Figure 30. Top Silkscreen

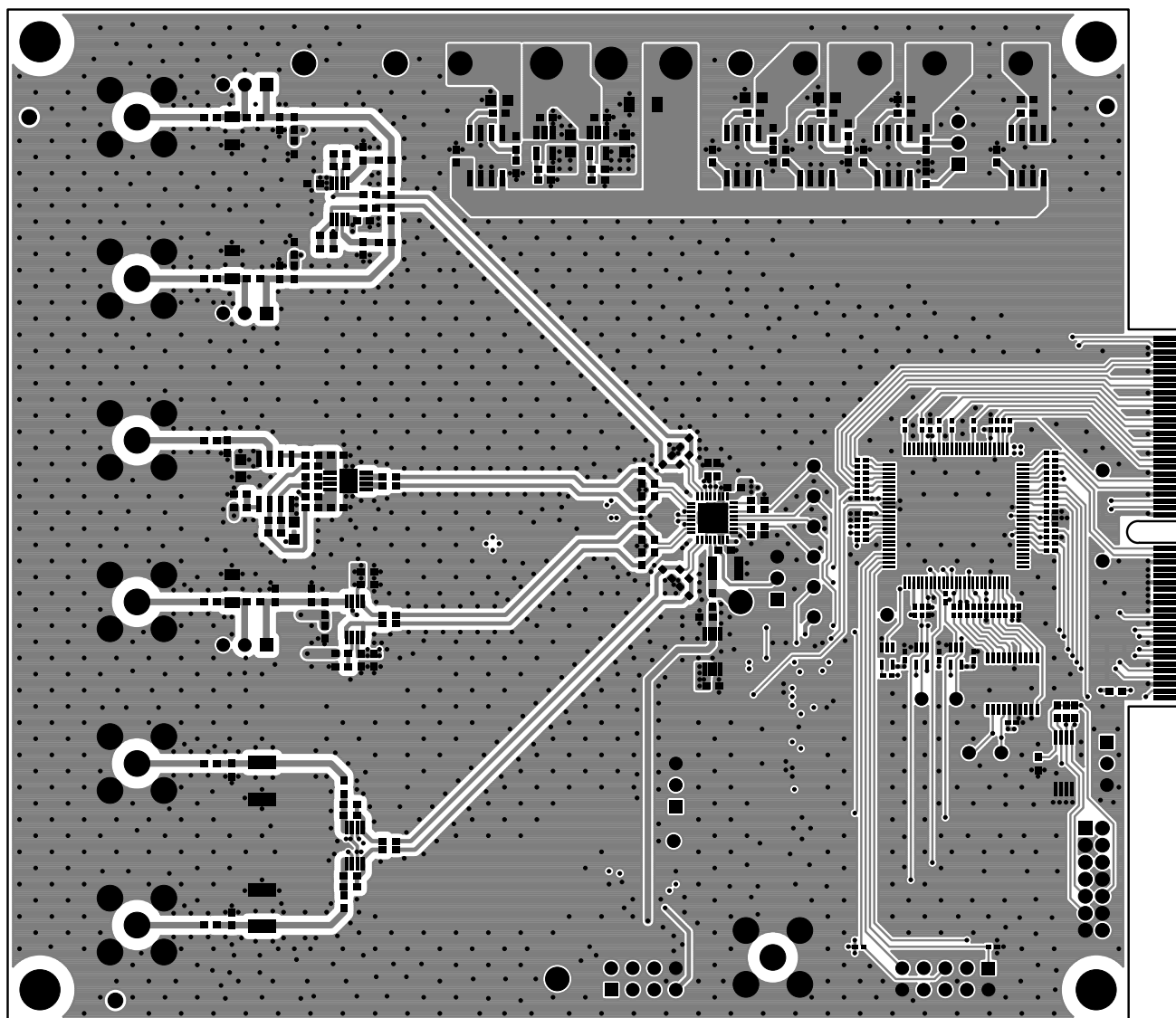
**BOARD LAYOUT**

Figure 31. Layer 1 Component Side

**BOARD LAYOUT**

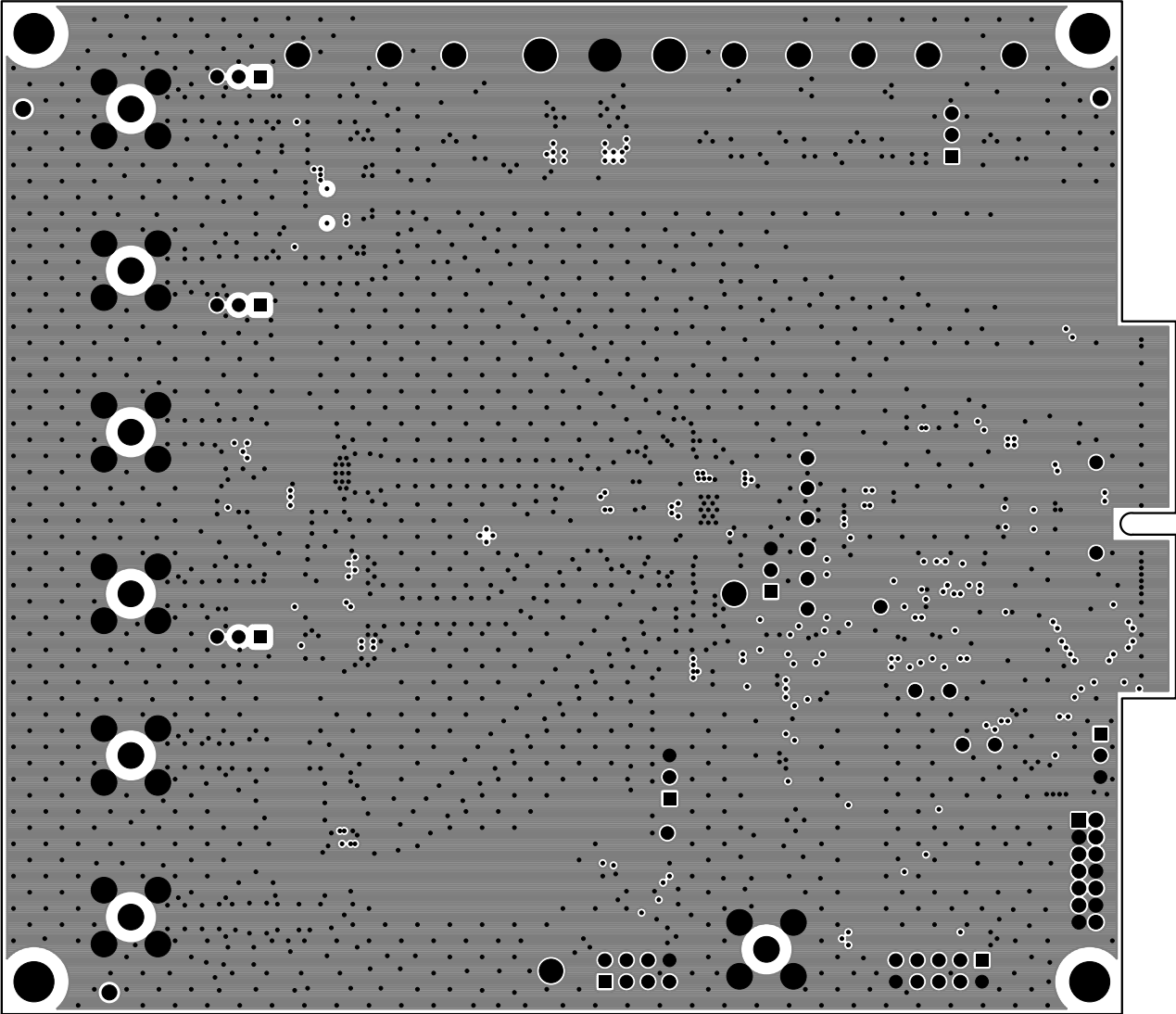


Figure 32. Layer 2 Ground Plane

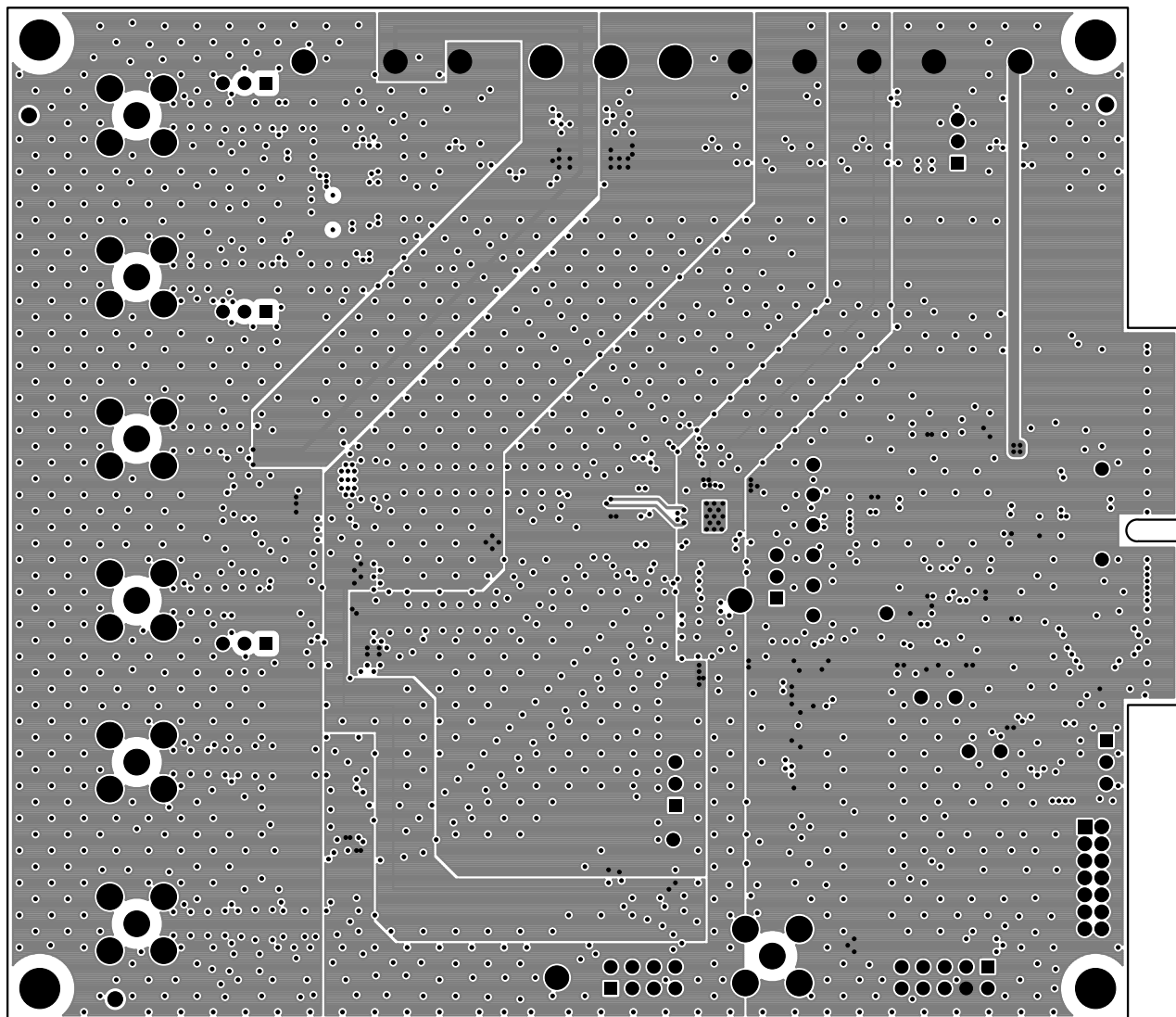
**BOARD LAYOUT**

Figure 33. Layer 3 Power Plane

**BOARD LAYOUT**

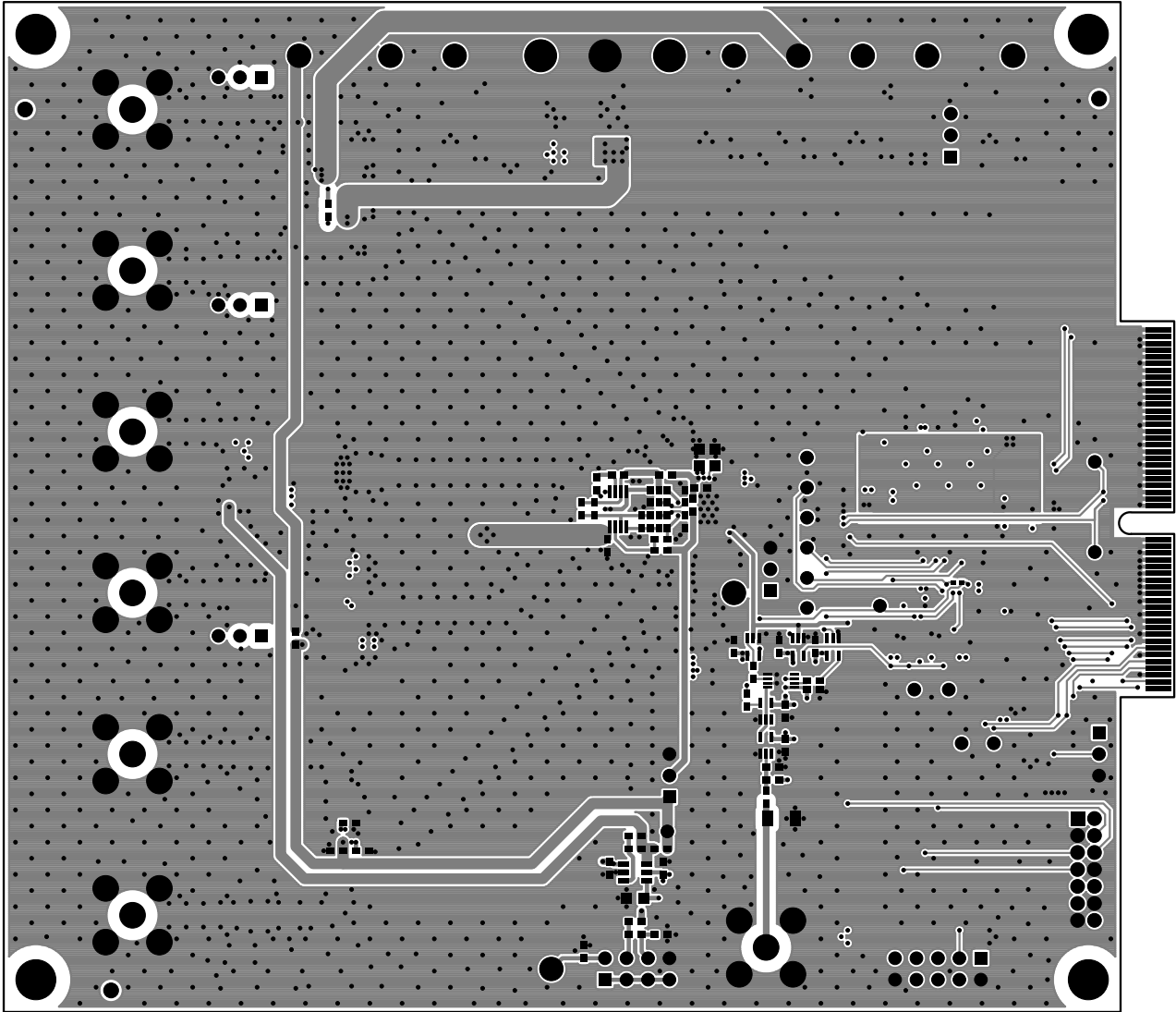
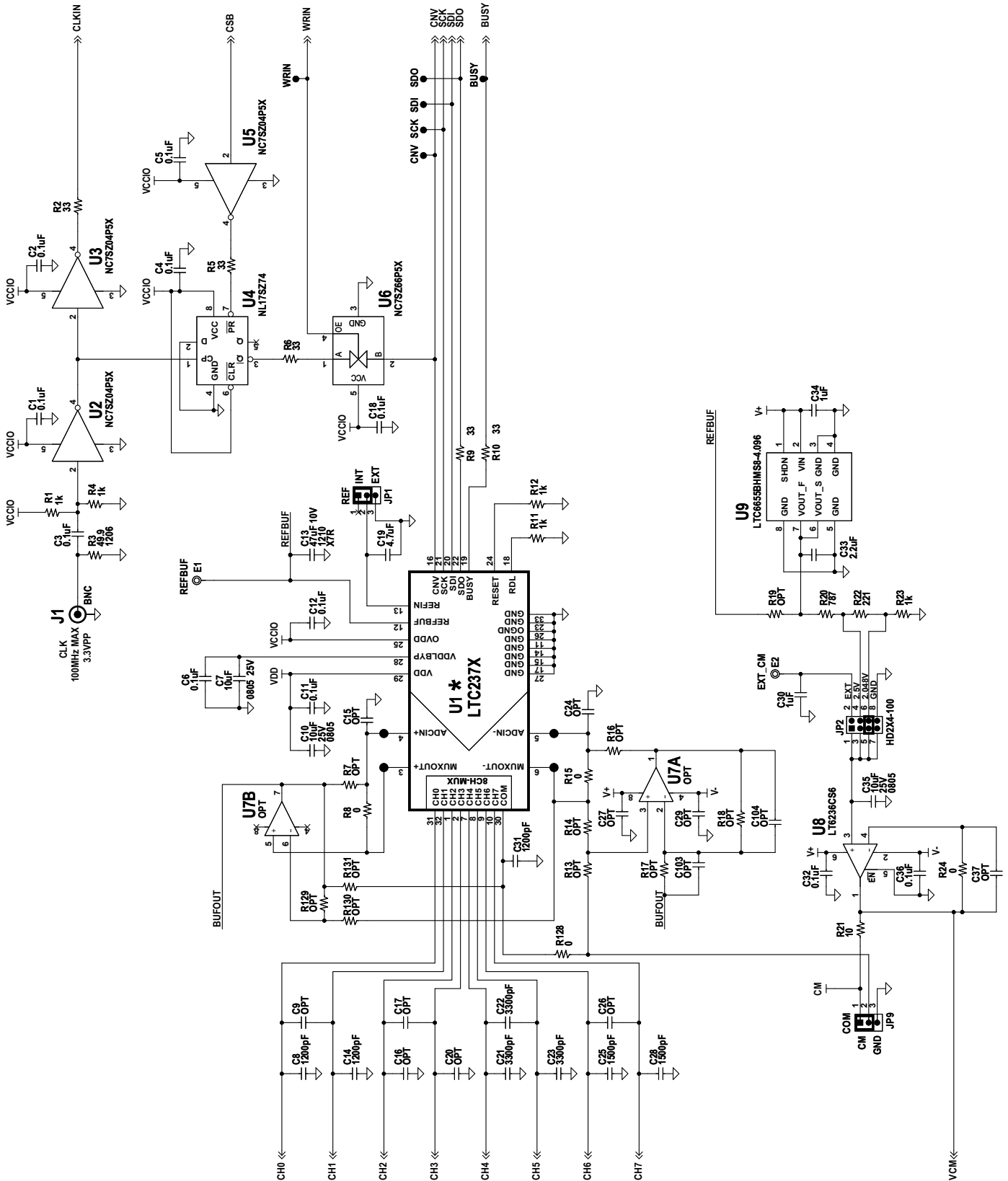
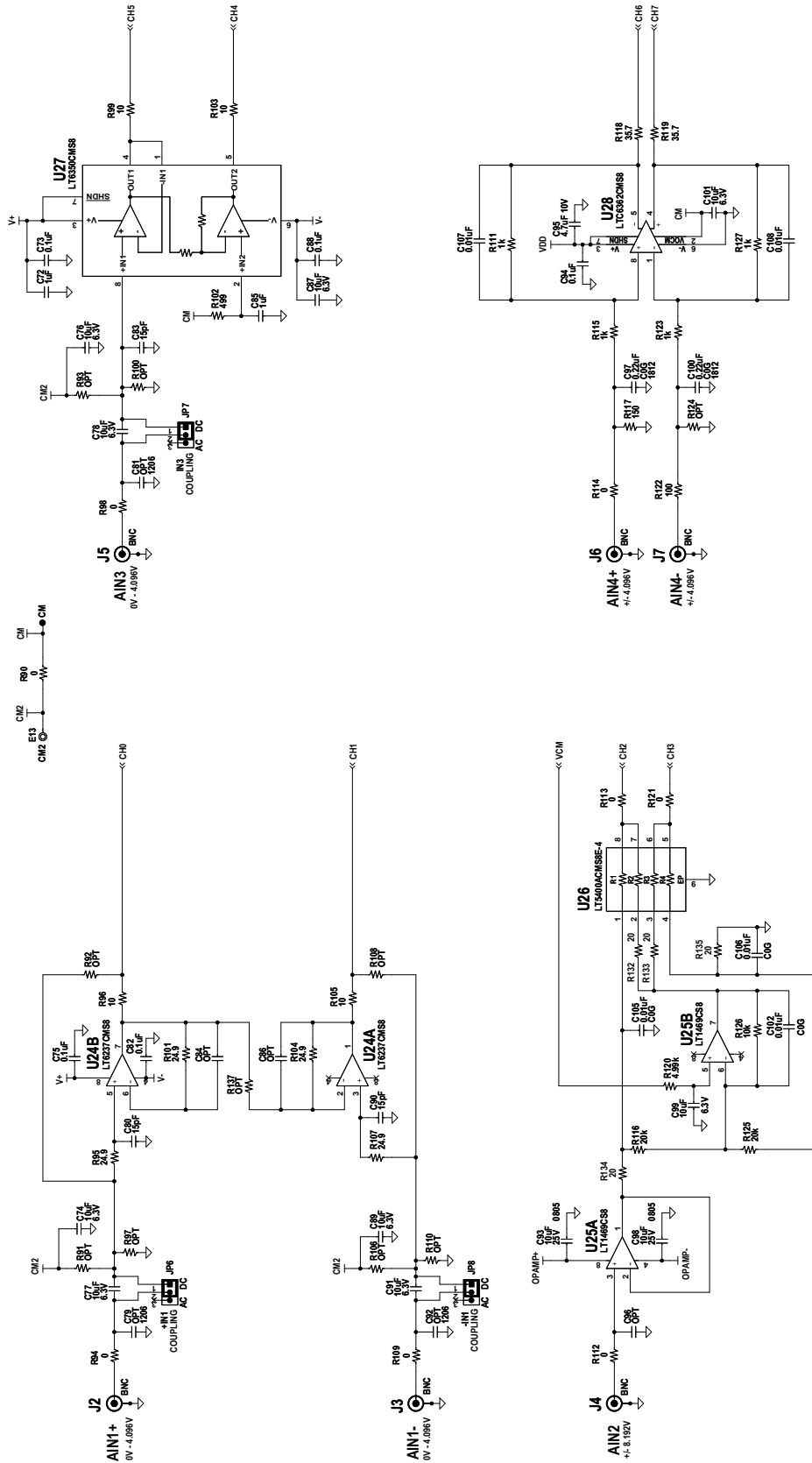


Figure 34. Layer 4 Bottom Layer

SCHEMATICS



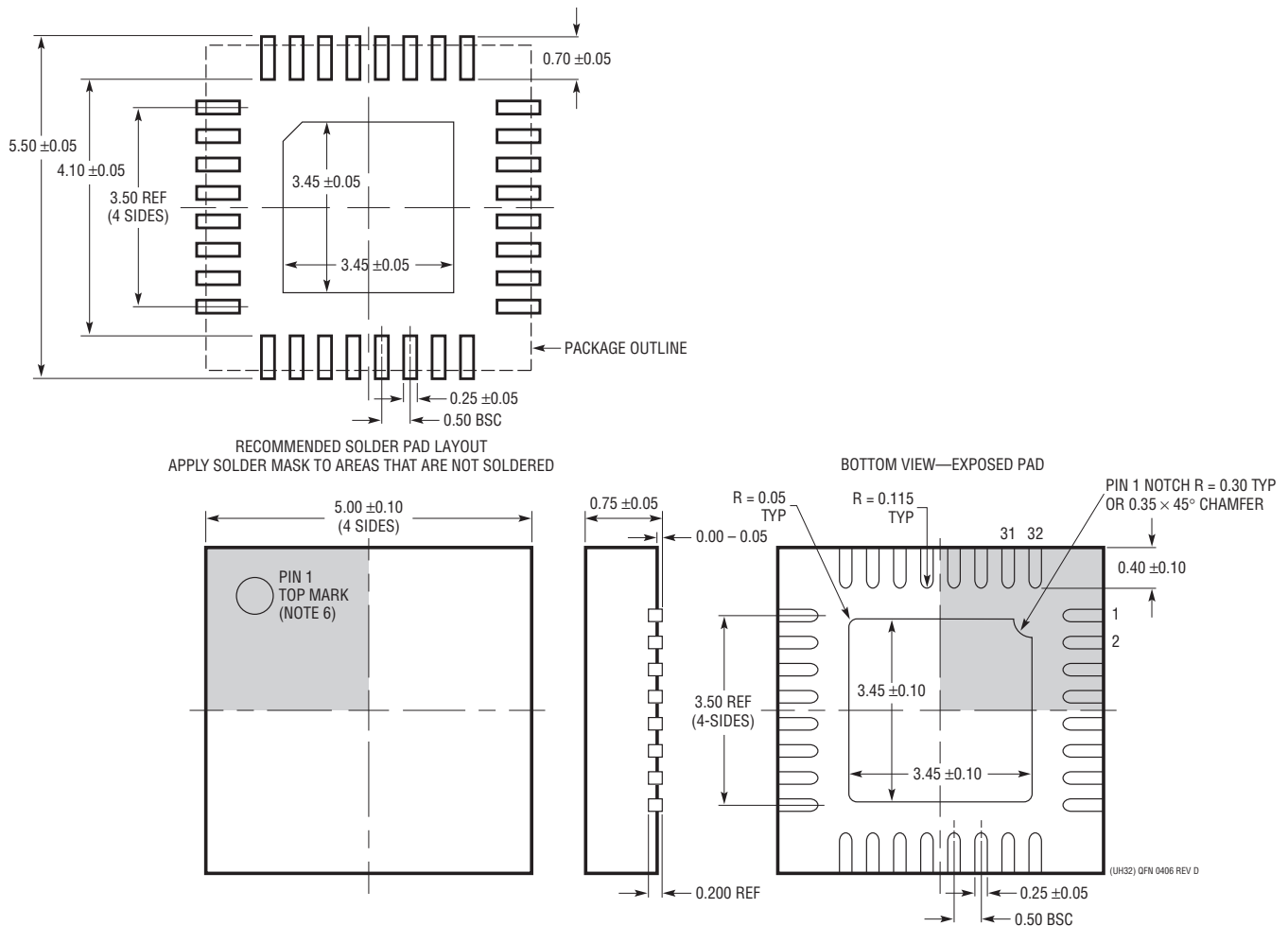
## SCHEMATICS



## PACKAGE DESCRIPTION

Please refer to <http://www.linear.com/designtools/packaging/> for the most recent package drawings.

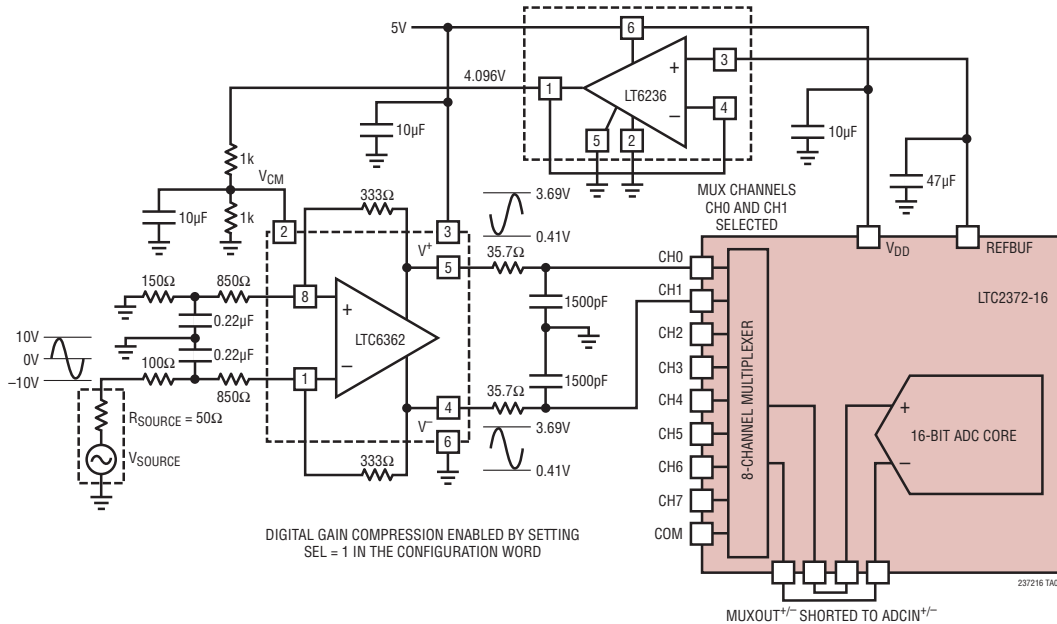
**UH Package**  
**32-Lead Plastic QFN (5mm × 5mm)**  
 (Reference LTC DWG # 05-08-1693 Rev D)



- NOTE:
1. DRAWING PROPOSED TO BE A JEDEC PACKAGE OUTLINE MO-220 VARIATION WHHD-(X) (TO BE APPROVED)
  2. DRAWING NOT TO SCALE
  3. ALL DIMENSIONS ARE IN MILLIMETERS
  4. DIMENSIONS OF EXPOSED PAD ON BOTTOM OF PACKAGE DO NOT INCLUDE MOLD FLASH. MOLD FLASH, IF PRESENT, SHALL NOT EXCEED 0.20mm ON ANY SIDE
  5. EXPOSED PAD SHALL BE SOLDER PLATED
  6. SHADED AREA IS ONLY A REFERENCE FOR PIN 1 LOCATION ON THE TOP AND BOTTOM OF PACKAGE

## TYPICAL APPLICATION

LTC6362 Configured to Accept a  $\pm 10\text{V}$  Input Signal Using a Single 5V Supply with Digital Gain Compression Enabled on the LTC2372-16



## RELATED PARTS

PART NUMBER	DESCRIPTION	COMMENTS
<b>ADCs</b>		
<a href="#">LTC2378-20/LTC2377-20</a> <a href="#">LTC2376-20</a>	20-Bit, 1Msps/500ksps/250ksps, $\pm 0.5\text{ppm}$ INL Serial, Low Power ADC	2.5V Supply, $\pm 5\text{V}$ Fully Differential Input, 104dB SNR, MSOP-16 and 4mm $\times$ 3mm DFN-16 Packages
<a href="#">LTC2379-18/LTC2378-18</a> <a href="#">LTC2377-18/LTC2376-18</a>	18-Bit, 1.6Msps/1Msps/500ksps/250ksps Serial, Low Power ADC	2.5V Supply, Differential Input, 101.2dB SNR, $\pm 5\text{V}$ Input Range, DGC, Pin-Compatible Family in MSOP-16 and 4mm $\times$ 3mm DFN-16 Packages
<a href="#">LTC2380-16/LTC2378-16</a> <a href="#">LTC2377-16/LTC2376-16</a>	16-Bit, 2Msps/1Msps/500ksps/250ksps Serial, Low Power ADC	2.5V Supply, Differential Input, 96.2dB SNR, $\pm 5\text{V}$ Input Range, DGC, Pin-Compatible Family in MSOP-16 and 4mm $\times$ 3mm DFN-16 Packages
<a href="#">LTC2369-18/LTC2368-18</a> <a href="#">LTC2367-18/LTC2364-18</a>	18-Bit, 1.6Msps/1Msps/500ksps/250ksps Serial, Low Power ADC	2.5V Supply, Pseudo-Differential Unipolar Input, 96.5dB SNR, 0V to 5V Input Range, Pin-Compatible Family in MSOP-16 and 4mm $\times$ 3mm DFN-16 Packages
<a href="#">LTC2370-16/LTC2368-16</a> <a href="#">LTC2367-16/LTC2364-16</a>	16-Bit, 2Msps/1Msps/500ksps/250ksps Serial, Low Power ADC	2.5V Supply, Pseudo-Differential Unipolar Input, 94dB SNR, 0V to 5V Input Range, Pin-Compatible Family in MSOP-16 and 4mm $\times$ 3mm DFN-16 Packages
<b>DACs</b>		
<a href="#">LTC2756</a>	18-Bit, Serial I <sub>OUT</sub> SoftSpan™ DAC	$\pm 1\text{LSB}$ INL/DNL, Software-Selectable Ranges, SSOP-28 Package
<a href="#">LTC2641</a>	16-Bit/14-Bit/12-Bit Single Serial V <sub>OUT</sub> DAC	$\pm 1\text{LSB}$ INL/DNL, MSOP-8 Package, 0V to 5V Output
<a href="#">LTC2630</a>	12-Bit/10-Bit/8-Bit Single V <sub>OUT</sub> DACs	SC70 6-Pin Package, Internal Reference, $\pm 1\text{LSB}$ INL (12 Bits)
<b>References</b>		
<a href="#">LTC6655</a>	Precision Low Drift Low Noise Buffered Reference	5V/2.5V/2.048V/1.2V, 2ppm/°C, 0.25ppm Peak-to-Peak Noise, MSOP-8 Package
<a href="#">LTC6652</a>	Precision Low Drift Low Noise Buffered Reference	5V/2.5V/2.048V/1.2V, 5ppm/°C, 2.1ppm Peak-to-Peak Noise, MSOP-8 Package
<b>Amplifiers</b>		
<a href="#">LT6237/LT6236</a>	Dual/Single Rail-to-Rail Output ADC Driver	215MHz GBW, 1.1nV/ $\sqrt{\text{Hz}}$ , 3.5mA Supply Current
<a href="#">LT6350</a>	Low Noise Single-Ended-to-Differential ADC Driver	Rail-to-Rail Inputs and Outputs, 240ns, 0.01% Settling Time
<a href="#">LTC6362</a>	Low Power, Fully Differential Input/Output Amplifier/Driver	Single 2.8V to 5.25V Supply, 1mA Supply Current, MSOP-8 and 3mm $\times$ 3mm DFN-8 Packages

237216f